

# CUB

CEREMONIES  
for Dens and Packs



# SCOUTS



BOY SCOUTS OF AMERICA®





THANKS TO YOU,  
MILLIONS OF BOYS

... BECOME MORE CONFIDENT

... GROW SPIRITUALLY

... ARE BETTER CITIZENS

... LEARN LIFE SKILLS

... HAVE FUN!

WITHOUT YOU, THEY WOULD NOT.

The Boy Scouts of America welcomes your comments and suggestions on how to improve this resource.

Please e-mail your thoughts to [CS.Ceremonies@scouting.org](mailto:CS.Ceremonies@scouting.org).



# CEREMONIES FOR DENS AND PACKS



# CONTENTS

## Cub Scout Ceremonies for Dens and Packs

<b>Chapter 1.</b>	<b>Introduction to Ceremonies .....</b>	<b>1-1—1-3</b>
<b>Chapter 2.</b>	<b>Den Ceremonies .....</b>	<b>2-1—2-7</b>
<b>Chapter 3.</b>	<b>Staging Pack Meeting Ceremonies.....</b>	<b>3-1—3-7</b>
<b>Chapter 4.</b>	<b>Flag Ceremonies .....</b>	<b>4-1—4-7</b>
<b>Chapter 5.</b>	<b>Pack Meeting Opening Ceremonies .....</b>	<b>5-1—5-12</b>
<b>Chapter 6.</b>	<b>Pack Meeting Closing Ceremonies .....</b>	<b>6-1—6-8</b>
<b>Chapter 7.</b>	<b>Induction Ceremonies .....</b>	<b>7-1—7-3</b>
<b>Chapter 8.</b>	<b>Advancement Ceremonies .....</b>	<b>8-1—8-14</b>
<b>Chapter 9.</b>	<b>Transition Ceremonies .....</b>	<b>9-1—9-5</b>
<b>Chapter 10.</b>	<b>Other Opportunities for Ceremonies .....</b>	<b>10-1—10-5</b>
<b>Chapter 11.</b>	<b>Outdoor and Campfire Ceremonies.....</b>	<b>11-1—11-3</b>
<b>Chapter 12.</b>	<b>Den Chief and Adult Ceremonies .....</b>	<b>12-1—12-5</b>
<b>Appendix.....</b>		<b>A-1—A-3</b>
<b>Index.....</b>		<b>I-1—I-6</b>



# CHAPTER 1

## Introduction to Ceremonies

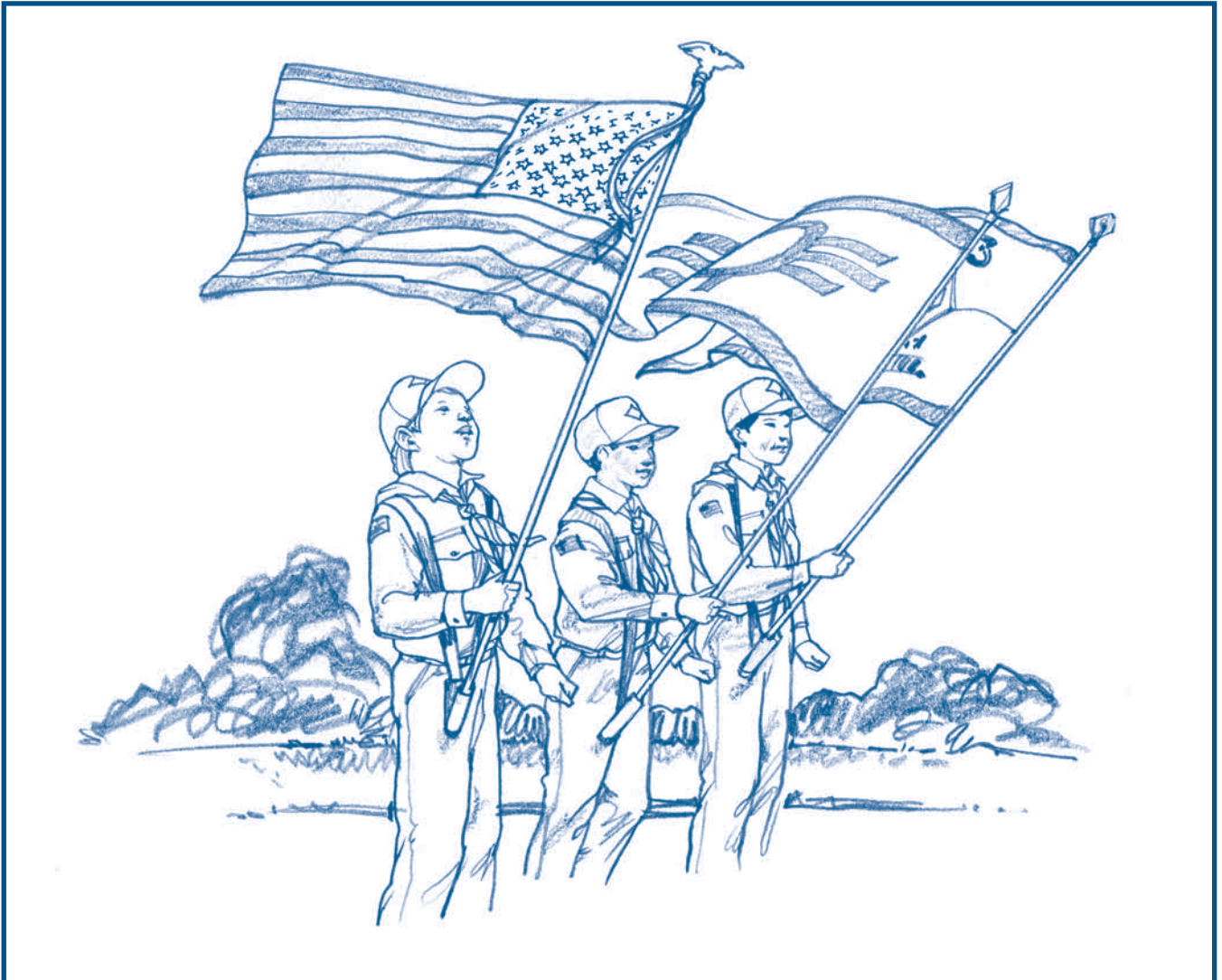

**Why Do We Use Ceremonies? 1-2**

**What Kinds of Ceremonies Are Used at Den Meetings? 1-2**

**What Kinds of Ceremonies Are Used at Pack Meetings? 1-2**

**Tips for Effective Ceremonies, 1-2**

**Tips for Using This Book, 1-3**

**Limitations? 1-3**

**Ceremonies Encourage Advancement, 1-3**

**What Is Advancement? 1-3**

**Cub Scout Advancement Goals, 1-3**



## Why Do We Use Ceremonies?

Ceremonies play an important part in our lives. We have ceremonies to celebrate birthdays, holidays, graduations, weddings, religious events, and many other special occasions. Ceremonies are also an important part of Cub Scouting.

Why do we have ceremonies in Cub Scouting?

- Everyone likes to receive recognition. A den or pack ceremony helps to recognize a boy in a positive way.
- Ceremonies provide meaningful and memorable highlights in a boy's Cub Scouting experience.
- Ceremonies help teach the ideals and goals of Scouting. As boys participate in ceremonies, they "learn by doing."
- Ceremonies focus attention not only on boys but also on families, leaders, and volunteers. All involved earn recognition for their accomplishments.

Ceremonies should be a regular part of den and pack meetings. Ceremonies define the beginning and the end of meetings, and they provide a format for presenting awards. Using ceremonies stimulates and encourages increased participation in monthly pack meetings.

Do you remember the best ceremony you ever saw? The worst? What was the difference between the two experiences? When you can answer these questions, you'll be ready to put what you know into practice and make a difference in the experience a boy will have when he receives his Tiger Cub badge or crosses a bridge into Boy Scouts. Cub Scouts will remember their awards and how they were recognized for earning them, and families will value these occasions as memorable highlights on the Scouting trail.

## What Kinds of Ceremonies Are Used at Den Meetings?

- An **opening ceremony** signals the beginning of the den meeting.
- The presentation of immediate recognition in fun and easy ceremonies acknowledges the **progression toward rank advancement**.
- **Denner installation** recognizes boy leaders and the importance of this position in the Cub Scout and Webelos den.
- **Special recognition** ceremonies mark special achievements reached both in and out of Scouting.
- A **closing ceremony** brings a quiet, inspirational end to the den meeting.

## What Kinds of Ceremonies Are Used at Pack Meetings?

- **Opening ceremonies** set the stage for the pack meeting and can reflect the Core Values.
- **Flag ceremonies** teach boys how to handle and present the U.S. flag in a respectful way.
- **Induction ceremonies** welcome new boys and their families into the pack.
- **Advancement ceremonies** celebrate the completion of requirements for Bobcat, Tiger Cub, Wolf, Bear, and Webelos ranks, and for the Arrow of Light Award.
- **Transition ceremonies** mark the transitions for Cub Scouts from Tiger Cub to Wolf, Wolf to Bear, Bear to Webelos Scout, and Webelos Scout to Boy Scout. They encourage boys to make the step up to their next challenge on the Scouting trail.
- **Closing ceremonies** bring the meeting to a close and send everyone home with inspirational ideas to think about.
- It is also important to remember **ceremonies for den chiefs and adults**. These ceremonies include den chief inductions, Den Chief Service Awards, den chief recognition, leader inductions, leader and family thank-yous, recognition of leader training, and Cub Scout leader recognition plan awards. These ceremonies let your leaders know that you appreciate the commitment they are making and their efforts toward bringing a quality program to the boys.

There are many other opportunities for ceremonies. Take the time to focus on the presentation of Gold Arrow Points, Silver Arrow Points, Webelos activity badges, Academics and Sports belt loops and pins, the World Conservation Award, National Summertime Pack Award, Fun for the Family Award, National Den Award, Cub Scout Outdoor Activity Award, Good Turn for America, Emergency Preparedness Award, and recognition of tenure and service projects. There are also presentations of Centennial Quality Unit Awards, pack charters, and special anniversary awards.

## Tips for Effective Ceremonies

When planning your ceremonies, remember these important points:

- **Know your audience.** Keep your ceremonies appropriate for boys of Cub Scout age. Simple ceremonies are more effective than long, elaborate ones. Boys this age have a short attention span.
- **Rotate responsibility** among the dens for the opening, flag, and closing ceremonies at the pack meeting. When boys are involved, it is easier to hold their attention during the pack meeting.



- Use a **variety** of ceremonies to hold the boys' and adults' interest. Keep track of which ceremonies you use and avoid repeating them month after month.
- **Adapt ceremonies** to meet your needs. Packs come in many different sizes, and boys come with different skill levels. Younger boys may need to have someone read their lines while they perform an action or hold a sign. No ceremony is written in stone. Volunteers have written or adapted those presented here to meet the needs of their packs. Feel free to change them to work for you! This makes them your ceremonies. Then try using the All-Purpose, All-Occasion Ceremony Creator in Chapter 10 to get started writing your own ceremonies.

## Tips for Using This Book

Use this book as a launching point for your ceremonies. Photocopy it, scan it, rewrite it! Highlight each person's part and tape it on the back of the prop that person may hold or use. Make sure that the print is large enough to be easily read, even in low-light conditions.

## Limitations?

All of us are better at some things than others. Some boys and adults in your pack may have additional challenges because of disabilities. When you plan ceremonies, check with adults, leaders, and boys to make sure they are comfortable with their parts. They will help you ensure that the ceremonies you use are both appropriate and fun for all to do. Everyone can play a part when you plan ahead.

## Ceremonies Encourage Advancement

Recognition is important to boys. When they are recognized for their accomplishments, they are motivated to achieve more. The advancement plan provides fun for the boys, gives them a sense of personal achievement as they earn badges, and strengthens family understanding as adult family members work with boys on advancement projects.

## What Is Advancement?

Advancement is one of the methods used to achieve the aims of Scouting in all phases of the Scouting program (Cub Scouting, Boy Scouting, and Venturing). The aims of Scouting are character development, citizenship training, and personal fitness.

Advancement is the process by which a Cub Scout meets certain requirements and receives recognition. He progresses from badge to badge, learning new skills as he goes. Advancement is simply a method or a means to an end, **not an end in itself**. Everything that is done to advance and earn these ranks, from joining until leaving the Scouting program, should be designed to help the boy have an exciting and meaningful experience in Scouting.

More information about advancement and recognition can be found in the *Cub Scout Leader Book*.

## Cub Scout Advancement Goals

The administration of the Cub Scout advancement program is primarily the responsibility of the pack committee, with the support of the district advancement committee and the commissioner staff. They work together to see that the following standards are met.

- The pack should maintain detailed advancement records to ensure that boys are advancing and that awards are presented promptly to each boy.
- Families of Cub Scouts should understand their roles and responsibilities in their boys' advancement. For the boy to receive maximum benefit and growth from his achievement, the standard for completion of any requirement should be based on the Cub Scout motto, "Do Your Best."
- Den chiefs (Boy Scouts, Varsity Scouts, or Venturers who help with Cub Scout and Webelos Scout den meetings) can help stimulate advancement through example, as well as encourage boys to continue in the Scouting program.
- Presentation of badges or other recognition items should be a part of **each** monthly pack meeting.
- Badges and other recognitions should be presented as soon as possible after a boy completes the requirements. He should be recognized during a ceremony at the monthly pack meeting.
- Packs and troops should be encouraged to work together to ensure a smooth transition from the Webelos den to the Boy Scout troop.
- Suggestions for advancement ceremonies may be found in the *Den & Pack Meeting Resource Guide*, the *Webelos Leader Guide*, the *Cub Scout Leader Book*, at monthly Cub Scout roundtables, and in this book.



# CHAPTER 2

## Den Ceremonies

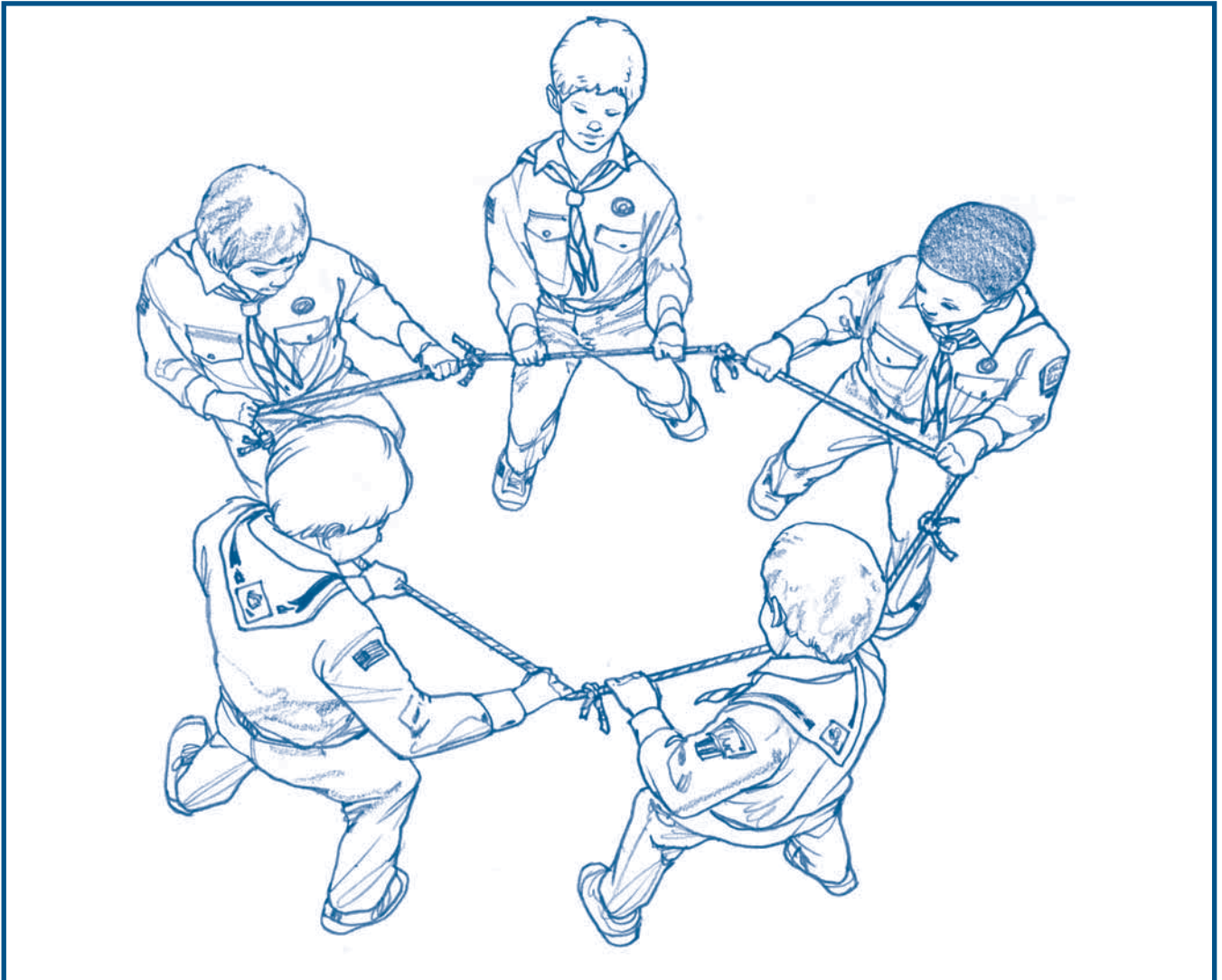

### Why Do We Have Den Ceremonies? 2-2 Ceremonies

Handshake Opening, 2-2

Tiger Cub Roll Call Opening, 2-2

Cub Scout Promise Opening, 2-2

Tiger Cub Opening Ceremony, 2-2

Orange Bead Recognition, 2-2

White Bead Recognition, 2-3

Black Bead Recognition, 2-3

Tiger Cub Closing, 2-3

Tiger Cub Closing Song, 2-3

Cub Scout/Webelos Scout Light, 2-3

Opening/Closing Song Ceremony, 2-3

Pledge of Allegiance Opening, 2-3

Roll Call Opening, 2-3

Den Flag Opening, 2-3

Law of the Pack/Scout Law Opening, 2-3

Cub Scout Promise/Scout Oath Opening, 2-3

Cub Scout/Scout Motto Opening, 2-3  
Den Yell Opening, 2-3  
Cub Scout Shirt Bobcat Recognition, 2-3  
Snowflake Immediate Recognition, 2-4  
Den Doodle for Advancement, 2-4  
Immediate Recognition Balloons, 2-4  
Immediate Recognition Fishing, 2-4  
Denner and Assistant Denner Installation, 2-4  
Denner and Cub Scout Stamp Installation, 2-4  
Brotherhood Circle Closing, 2-4  
Handshake Closing, 2-4  
Leader's Minute Closing, 2-5  
Flag Folding Closing, 2-5  
Den Yell Recognition Ceremony, 2-5  
Friendship Circle Closing, 2-5

Grand Howl Recognition Ceremony, 2-5  
Living Circle Closing, 2-5  
Meaning of the Cub Scout Promise  
or Scout Oath Closing, 2-5  
Mountain Climbing Closing Thought, 2-5  
My Flag Closing, 2-5  
Patriotic Song Closing, 2-5  
Square Knot Closing, 2-5  
We Meet as Cub Scouts Closing, 2-5  
Den Doodles, 2-6

## Why Do We Have Den Ceremonies?

When ceremonies are used in dens, boys have the opportunity to really understand what is happening because they play an active part.

- A flag ceremony or patriotic opening helps them learn about their American heritage.
- Installing a boy as a denner helps him learn that responsibilities come with a title and his leadership is important to the den.
- Immediate recognition toward advancement inspires other boys to work with their families on achievements.
- Opening and closing ceremonies mark the beginning and end of the den meeting and encourage appropriate behavior during the meeting.

Variety is as important as length. Den ceremonies should be kept short (no longer than two or three minutes). Use the planning forms, Tiger Cub Den Meeting Program, Cub Scout Den Meeting Program, or Webelos Den Meeting Program, to plan your ceremonies. Remember to keep them simple and effective.

### Handshake Opening

The denner calls the roll, and each member of the den comes forward and gives him the Cub Scout handshake. Webelos Scouts could give the Scout handshake.

### Tiger Cub Roll Call Opening

As the den meeting host calls roll, each Tiger Cub team responds with a loud tiger growl.

### Cub Scout Promise Opening

The Tiger Cubs form a large circle. Their adult partners form an outer circle by standing behind their Tiger Cubs. All say the Cub Scout Promise in unison.

### Tiger Cub Opening Ceremony

Each Tiger Cub holds a poster with a letter on it. After he shouts his letter, his adult partner reads the statement matching the letter.

ADULT 1: T is for TEAM, the Tiger team, a boy and his adult partner having fun together.

ADULT 2: I is for INTRODUCTION, showing us what Cub Scouts is all about.

ADULT 3: G is for GOOD TIMES, having fun together as a den and with your family.

ADULT 4: E is for EXPLORING, searching out new things to see and do.

ADULT 5: R is for READY, ready for new adventures together as a team.

ADULT 6: S is for SHARING, taking time to talk to each other about the fun things we get to do.

### Orange Bead Recognition

**Preparation:** Put orange activity beads in a cloth pouch. The narrator is the adult partner who is hosting the meeting. The narrator's Tiger Cub distributes the beads.

**NARRATOR:** Today, we experienced the fun of completing a den meeting requirement for the Tiger Cub badge. In recognition of today's activity, an orange bead will be added to your Tiger Cub immediate recognition emblem. *(The narrator's Tiger Cub partner distributes one orange bead to all the adult partners. The adult*

*partners attach the beads to the boys' immediate recognition emblems.)*

## White Bead Recognition

**Preparation:** Put white beads in a small box decorated to look like a treasure chest.

**NARRATOR:** Today, we would like to present a special bead from our den treasure chest to the Tiger Cubs who have completed a Tiger Cub rank requirement with their families. Tiger Cub [Name] and his adult partner please step forward. This Tiger Cub and his family have completed a required activity together. (*Ask the boy to tell about the activity.*) As a memento of the treasure of time your family spent together, I am presenting a white bead to your adult partner to attach to your Tiger Cub Immediate Recognition Emblem. (*Lead the den in the den cheer or a tiger growl.*)

## Black Bead Recognition

**Preparation:** Put black beads in a daypack or travel kit.

**NARRATOR:** Today, we went to [Go See It location]. In recognition of completion of this requirement toward the Tiger Cub rank, we would like to present a bead to each Tiger Cub. This is to remind you of your visit to [Go See It location]. I am presenting a black bead to your adult partner to attach to your immediate recognition emblem.

## Tiger Cub Closing

The Tiger Cubs and their adult partners stand in a circle and hold hands. In turn, each adult partner tells one thing the Tiger Cub did since the last meeting to show that he did his best. End with everyone reciting the Cub Scout motto.

## Tiger Cub Closing Song

Divide the singers into two groups. The first group sings the first verse. The second group responds with the second verse. Repeat, singing faster each time. (Tune: "The Muffin Man.")

Can you find a Tiger Cub,  
A Tiger Cub, a Tiger Cub?  
Can you find a Tiger Cub  
With black and orange bold stripes?  
Yes, we found a Tiger Cub,  
A Tiger Cub, a Tiger Cub.  
Yes, we found a Tiger Cub  
With black and orange bold stripes.

## Cub Scout/Webelos Scout Light

The den leader asks den members to sit on the floor in a circle and dims the lights. Have a small candle and larger candle, plus matches, on a table. Flashlights or battery-operated candles may be used instead of regular candles and matches.

**DEN CHIEF:** I will light this small candle. It represents the goodwill given by one Cub Scout [or Tiger Cub or

Webelos Scout]. See how it shines? The rays from several Cub Scouts [Tiger Cubs/Webelos Scouts] make a brighter light. Each Scout lets his light shine by doing his best and helping other people.

**DEN LEADER:** I'll light this large candle. This represents that there is a brighter light that leads us all. Let us always think first of God, second of others, and finally of ourselves.

## Opening/Closing Song Ceremony

Select a song from the *Cub Scout Songbook* to sing as your opening or closing. You might also select a song related to the monthly Core Value or Webelos activity badge to sing as the opening or closing ceremony.

## Pledge of Allegiance Opening

The den gathers in a semicircle or horseshoe formation. One boy presents the colors (the U.S. flag) at the open end of the horseshoe. In turn, each boy steps forward, gives the Cub Scout salute, and steps back. Follow with the Pledge of Allegiance.

## Roll Call Opening

The denner calls roll, and the boys respond by naming an item related to the Core Value or activity badge for the month.

## Den Flag Opening

The den forms a tight circle with the den flag in the center. Each boy grasps the flagpole with his left hand, makes the Cub Scout sign with his right hand, and says the Cub Scout Promise.

## Law of the Pack/Scout Law Opening

The den forms a circle, gives the Cub Scout salute, and says the Law of the Pack. [Webelos Scouts give the Scout salute and say the Scout Law.]

## Cub Scout Promise/Scout Oath Opening

Select a phrase from the Cub Scout Promise and talk about its meaning. [Webelos Scouts discuss a phrase from the Scout Oath.]

## Cub Scout/Scout Motto Opening

Talk about the meaning of the Cub Scout motto. Say it in unison. [Webelos Scouts talk about the meaning of the Scout motto and say it in unison.]

## Den Yell Opening

Give your den yell.

## Cub Scout Shirt Bobcat Recognition

**Preparation:** Cut a piece of blue cardboard into the size and shape of a Cub Scout shirt with pockets on it and a hand-drawn version of the Bobcat badge (or a Bobcat badge sticker).



DEN LEADER: This Cub Scout shirt is very plain and could belong to anyone. It represents a sense of belonging and friendship in our den. Once you place the Bobcat badge on this shirt, it shows that our Scout has new knowledge and skills. Today, we have some den members who have earned this special recognition. Congratulations!

### **Snowflake Immediate Recognition**

**Preparation:** Cut out paper snowflakes and hang an immediate recognition bead from each one.

DEN LEADER: Snowflakes begin to appear one at a time, and each one takes its own form. Will [den member] please come forward. *(Present the snowflake.)* With each of you working on achievements, we will soon make a snowstorm out of our snowflakes. All of us can encourage one another!

### **Den Doodle for Advancement**

**Preparation:** Have a bead or other object ready to be attached to the den doodle for each achievement or award that will be recognized. After all achievements are presented, the den leader says the achievement pledge, and the den members repeat it, line by line.

DEN LEADER: We have a boy (or boys) ready to add an achievement to his (or their) string on the den doodle. He has (or they have) been working hard and completed an achievement (or activity badge) toward his Wolf (or Tiger Cub or Bear or Webelos) badge. Congratulations, [Name]! Keep up the great work! *(Present him with a bead or other object to attach to his area on the den doodle.)* While he is adding this to his string, let's repeat our den achievement pledge:

We, the boys of den [number], *(Boys repeat.)*  
Promise to do our best, *(Boys repeat.)*  
To keep working on our achievements, *(Boys repeat.)*  
And really pass the test. *(Boys repeat.)*

### **Immediate Recognition Balloons**

Put immediate recognition beads inside balloons and then blow up the balloons. Let the boys pop the balloons to receive their immediate recognition.

### **Immediate Recognition Fishing**

Make a fishing pole from a stick and string, and attach a magnet for the hook. Attach a paper clip or a pin to the immediate recognition beads. Have the boys fish for their awards.

### **Denner and Assistant Denner Installation**

**Preparation:** Set a white candle and matches or flashlight to light it where everyone can see it. Have a denner shoulder cord ready to present to the chosen boy.

DEN LEADER: Cub Scout/Webelos Scout [Name of new denner], will you please step forward and light our can-

dle. *(The denner lights the candle.)* This white candle represents the spirit of Scouting. It takes team effort to keep the spirit alive—to keep the candle burning. You have just been elected to be a member of that team.

As denner, your duties are to assist our den. You will help record attendance and collect den dues. *(These duties may vary depending on the den.)*

During the week, you will set a good example for the other members of our den by being honest and fair, and showing true Scouting spirit.

Do you accept these responsibilities?

DENNER: I will do my best.

DEN LEADER: I'm happy to present to you the denner cord, which is to be worn on your left sleeve during your term of office. Wear it proudly and with honor. Congratulations!

Cub Scout/Webelos Scout [Name] has been selected to be our assistant denner. His duty will be to help our denner in his duties. Do you accept your responsibilities?

ASSISTANT DENNER: I will do my best.

DEN LEADER: We present to you the assistant denner cord that is to be worn on your left sleeve during your term of office. Congratulations!

### **Denner and Cub Scout Stamp Installation**

**Preparation:** Secure a rubber stamp with the Cub Scout symbol on it and a washable ink stamp pad. Have a denner shoulder cord ready to present to the chosen boy.

DEN LEADER: *(Stamp the right band of the new denner.)* As our denner, you will have the responsibility of assisting our den chief and me. Will you do your best to help our den along the advancement trail and share with them the work and fun of Scouting?

DENNER: I will do my best. *(Present the denner cord.)*

### **Brotherhood Circle Closing**

**Preparation:** Form the den in a brotherhood circle: Each boy places his left arm around the shoulder of the boy on his left and his right arm around the shoulder of the boy on his right.

DEN LEADER or DEN CHIEF: Now may the Great Master of all Scouts be with us until we meet again.

### **Handshake Closing**

Have the boys give the Cub Scout handshake to the den leader and den chief and then leave quietly. Another version is to have the boys form a circle and pass the handshake from one to another around the circle until it reaches the boy who started it. As each boy receives the handshake, he silently makes a wish and pledges to do his best.

Tiger Cubs and Cub Scouts use the Cub Scout handshake. Webelos Scouts use the Scout handshake.



## Leader's Minute Closing

This is a closing inspirational thought. It can be a brief story about the Cub Scout Promise, the Scout Oath, the Law of the Pack, the Scout Law, the motto, or something patriotic. It could reflect ideals such as being kind to animals and people, showing sportsmanlike behavior, or participating in school activities. It is told without moralizing.

## Flag Folding Closing

Have three boys fold the flag while the other boys stand respectfully in a semicircle.

## Den Yell Recognition Ceremony

Den members form a circle around the den flag. They give their den yell in honor of those den members who completed an achievement or elective this month.

## Friendship Circle Closing

Den leaders and members form a friendship circle: Cross arms with right arm over left and grasp the hands of people on each side. They then sing a closing song.

## Grand Howl Recognition Ceremony

Cub Scouts form a circle around the person in whose honor the grand howl is to be given. This may be a visitor, the den chief, a new den member, or a Cub Scout who has earned the respect of the "wolves." Each boy squats, makes the Cub Scout sign with both hands, and touches them to the ground between his feet. Then, like young wolves, the Cub Scouts raise their heads and give a long howl. As the last word is yelled, everyone jumps to his feet, and raising his right hand high above his head, gives the Cub Scout sign.

DEN MEMBERS: Akela! We'll—do—our—best!

## Living Circle Closing

Den leaders and den members form a close circle and turn to their right, each placing his left hand into the center of the circle, palm facing downward. Each person grasps the thumb of the person behind him, making a complete circle with the group. Everyone's right hand is held straight up in the Cub Scout sign. One version is to pump joined hands up and down seven times as all say, "Akela! We'll—do—our—best!" You can also use the Cub Scout Promise, Law of the Pack, Cub Scout motto, or your own personal words in place of this chant.

## Meaning of the Cub Scout Promise or Scout Oath Closing

Den members form a circle, and each person says one sentence of the Cub Scout Promise and then explains what this sentence means to him. Webelos dens could use the Scout Oath.

## Mountain Climbing Closing Thought

**Preparation:** Ask the boys to sit in a circle with the den leader and close their eyes.

DEN LEADER: Picture a very high mountain. It is beautiful but very dangerous. It has slippery glaciers and high rocky places you can climb only with special equipment and with help from other people. Mountain climbers depend on each other. They must be able to trust their friends at the other end of the rope. When you pick your friends, think about whether this is a person you could trust at the end of that rope. Let's have a moment of silence as we think about the good friends we have chosen.

## My Flag Closing

Right before the ending, the den leader asks each boy to write a sentence about what the U.S. flag means to him. For the closing ceremony, read the statements.

## Patriotic Song Closing

Den members form the den in a circle around the U.S. flag. Everyone salutes and sings "America", "God Bless America," or another patriotic song. (See the *Cub Scout Songbook* for ideas.)

## Square Knot Closing

**Preparation:** Give each boy a 3-foot section of rope. The boys tie the rope with a square knot to each other's ropes to form a complete circle. They all lean back carefully to form a taut circle.

DEN LEADER: You are part of a group of close friends, held together by the square knot—a symbol of friendship.

## We Meet as Cub Scouts Closing

**Preparation:** Have the boys form a circle.

DEN LEADER: We meet as Cub Scouts [Tiger Cubs, Webelos Scouts], we part as friends, as now we leave, our meeting ends.

Let this circle be a token of friendship, as Akela guides us home.

## Den Doodles

Many dens use a den doodle to encourage advancement. A den doodle is an emblem, figure, or other object that visually records the progress of the boys in a Tiger Cub, Cub Scout, or Webelos den. Each boy can add something to his string on the den doodle as he completes advancement requirements.

The doodles are the most fun when the boys help make them, after deciding on a theme that fits their den. No two dens make doodles that are alike. Each one is distinctive and has the den's number, a place for each boy's name, and a cord or thong for his record.

Buttons, corks, paper beads, spools, bottle tops, wooden beads, pasta, cutouts, and shells are a few of the items used as symbols of progress. Each symbol, or device, is usually identified with the name of the recognition, such as Wolf Achievement 1, and the date. The boys will look forward to hanging devices on the doodle as they complete achievements and electives and earn Webelos activity badges.

Additional devices can be included to recognize attendance, wearing the complete uniform, remembering to bring their books to den meetings, or other desired behavior. Beads can be added to commemorate special events during the year. You are limited only by your imagination.

Doodles can be either a table model or floor model. The base can be a coffee can filled with plaster or a device designed using inexpensive plastic pipe and connectors. More examples of den doodles are found in the *Cub Scout Leader Book* and the *Cub Scout Leader How-To Book*.

When an addition is made to the den doodle, acknowledge it with a short ceremony at the den meeting. Take the den doodle to pack meetings and proudly display it next to the den flag.

Use your imagination in creating a den doodle. Scrounge for inexpensive supplies. Look for design ideas in children's coloring books or in clip-art collections. Let the boys choose the design of their den doodle.

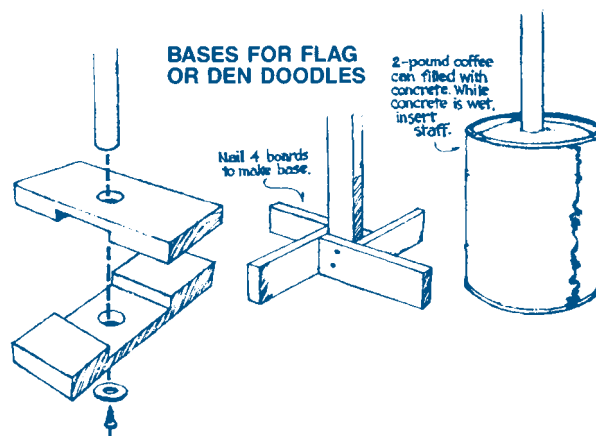

For the base of your den doodle:

1. Plan a wooden removable base.
2. Mix concrete in a coffee can, cover pole with foil and insert while concrete is wet. Let the concrete harden and then remove the covered pole.
3. Use inexpensive plastic PVC pipe and connectors to create a removable base.

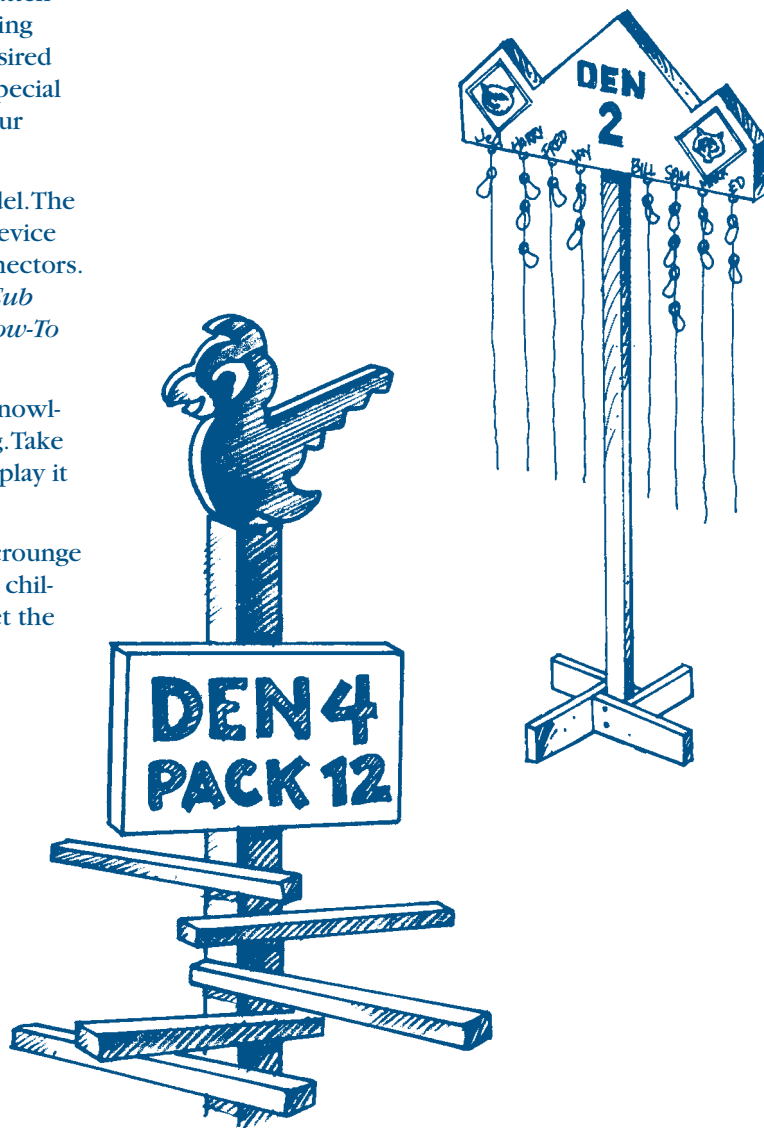

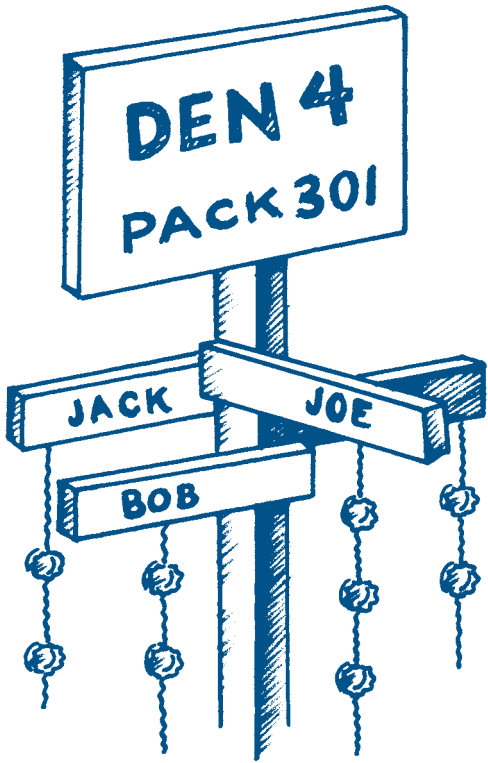

Wooden coat hanger

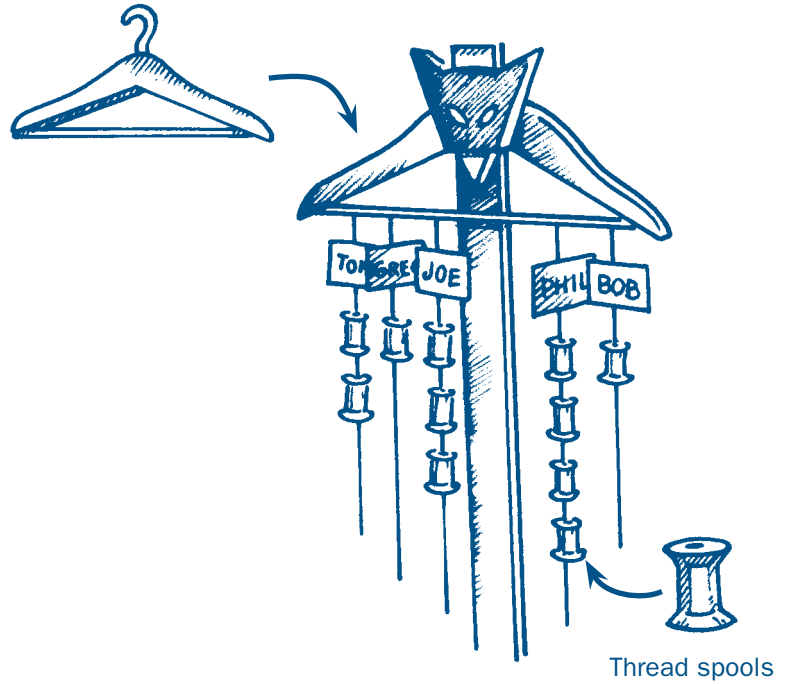

Colored cardboard or wooden disks can be added for each achievement or elective completed. Use different colors for each rank.

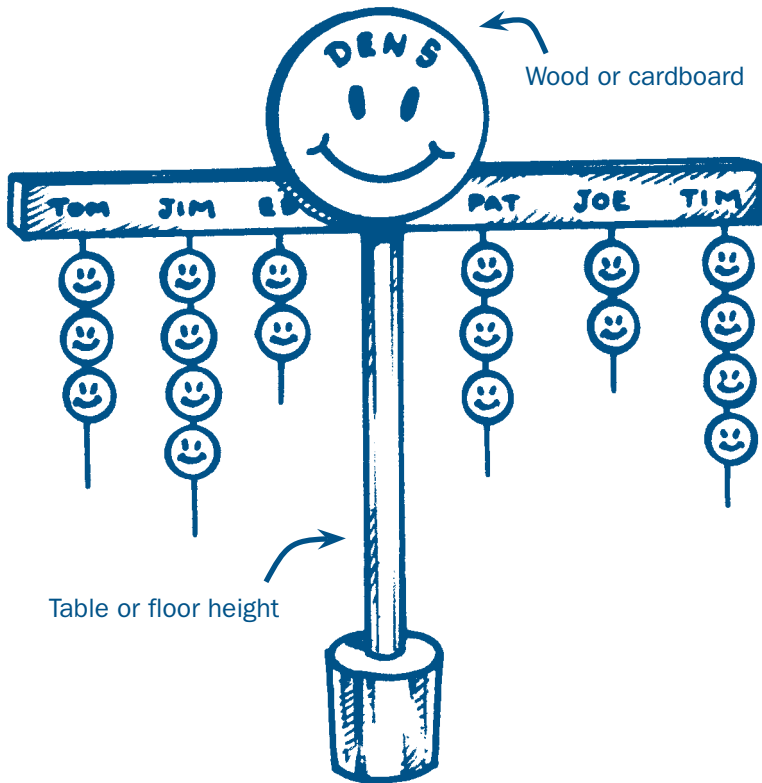

Wood or cardboard

Table or floor height

Dowel

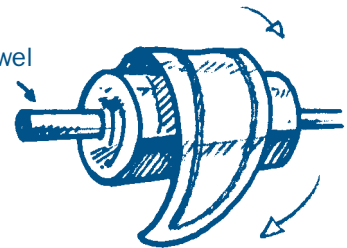

**PAPER BEADS:** Cut colorful magazine pages into long triangles. Dip in a thin solution of glue and water and roll on dowels or straws. Let them dry, then remove from the dowels or straws. Boys love this messy job!



# CHAPTER 3

## Staging Pack Meeting Ceremonies



**Planning Your Pack Ceremonies, 3-2**

**Pack Meeting Layout, 3-2**

**Den Award and Appreciation Ideas, 3-2**

**Pack Ceremony Equipment, 3-3**

**Scouting Clip Art to Use in Ceremonies, 3-5**

**Music in Ceremonies, 3-7**



# Planning Your Pack Ceremonies

Think of your pack meetings as an opportunity to use the magic of ceremonies to instill the values of Cub Scouting in the hearts of boys and adults. You'll have several opportunities to do this throughout your meeting:

- Flag ceremony
- Opening ceremony
- Inducting new families into the pack
- Advancement ceremony
- Transition ceremony
- Other opportunities
- Closing ceremony

You'll find a chapter devoted to each of these in this book. The pack committee will want to use the annual pack program planning conference to outline the Core Values to be spotlighted in ceremonies each month and for timing major events such as transitions and a pine-wood derby. At the monthly pack leaders' meeting, one may fill in the details of which ceremonies will be used and who is responsible for doing them. The Pack Meeting Planning Sheet in the *Cub Scout Leader Book* will help with this process. Just remember to use a variety of ceremonies to hold the interest of both boys and adults.

## Pack Meeting Layout

The layout of your pack meetings will depend on your facilities. It is important for everyone to be able to see what is going on in the front of the room. When boys can see and hear what is taking place, they will be less easily distracted. Boys are inexperienced at projecting their voices, so the closer they are to the audience, the more likely it is that everyone will be able to hear what they are saying in ceremonies and skits.

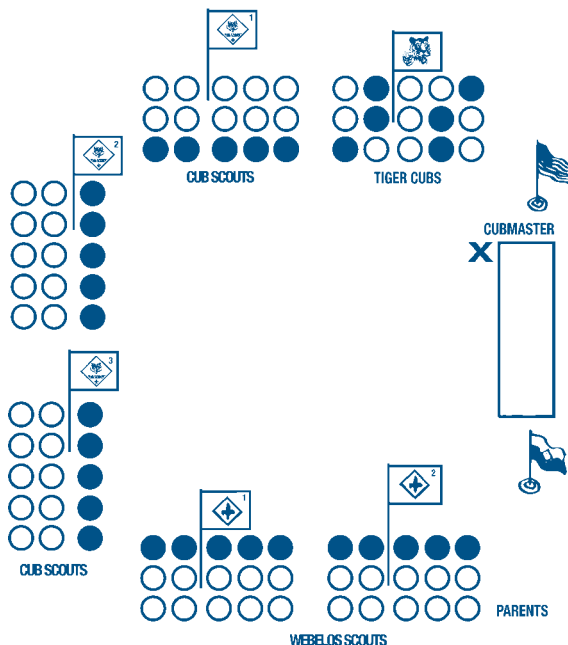

Seat boys by dens and have families sit in the same area. Make sure that your aisles are wide enough for everyone to maneuver through, including those with physical disabilities. For the same reason, consider carefully the use of stages, which may discourage the participation of boys or adults of all ages who have difficulty walking up and down stairs. Darkened circles in the diagram are boys; remaining circles are family members.

## Den Award and Appreciation Ideas

At your pack meetings, use a simple, homemade award to recognize the den that did a community service project or the adult who organized your school roundup night. This is a positive way to recognize and thank the people in your pack.

Be creative and attach one of the following items to a string or a piece of wood, cardboard, or leather to create a den award or thank you. Ask the den or person to come forward and make a brief statement about what they accomplished.

Keep your eyes open for special opportunities that give you the chance to tell people you appreciate their efforts.

- |                        |   |
|------------------------|---|
| Airplane               | Really helped us fly                      |
| Antacid                | Added fizz to...                          |
| Bag of tea             | Tea-riffic job                            |
| Ball                   | Being on the ball                         |
| Adhesive bandage       | Helped fix up...                          |
| Baseball and bat       | Pitches in where needed                   |
| Battery                | Charged us up                             |
| Bees                   | Busy bees                                 |
| Berry (wax or plastic) | Berry good job                            |
| Bottle of glue         | Stuck to it                               |
| Burnt piece of toast   | Well done award                           |
| Chalkboard             | Chalked up a great...                     |
| Cheese grater          | Grate job (great job)                     |
| Clock                  | Found extra time to...                    |
| Clothespin             | Hanging in there                          |
| Coat hanger            | Hanging in there                          |
| Compass                | Leads the way                             |
| Eyes (plastic wiggly)  | Set the example for us                    |
| Fire engine            | Came to the rescue                        |
| Fishing pole           | Really caught the spirit                  |
| Flashlight             | Shining example or lights the way         |
| Frog                   | Hopped to it                              |
| Glue stick             | Stuck to it                               |
| Golf tee               | Tee-rific job                             |
| Gum                    | Thanks for chew-sing<br>to do a great job |
| Hat                    | Hat's off to...                           |
| Heart, gold            | Heart of gold when...                     |
| Heart, red             | Shows great heart by...                   |



Key	Key to success
Kite	Flying high
Light bulb	Good ideas
Lion	Roaring success
Magic wand	Worked magic in...
Magnet	Stuck with it
Marbles in a bag	Marble-ous job
Million dollars (play money)	Thanks a million, worth a million
Needle and thread	Kept us in stitches
Newspaper bundle	Thanks a bundle
Packet of seeds	Helping the pack grow
Pair of glasses	See things clearly
Pencil	Write on (right on!)
Plastic egg	Good egg by helping the pack
Playing cards	Great hand, can't be beat
Puzzle	Knows how to tackle challenges
Recipe	All the ingredients for...
Red or gold reflector	Reflects Cub Scout spirit when...
Right shoe or footprint	On the right foot
Ruler or tape measure	Really measures up
Sandpaper	Smoothed the way to...
Scissors	Cut out for...
Seal	Seal of approval
Shovel	Really dug into the job
Small horn	Music to our ears when...
Small notepad	Most noteworthy
Spaceship	Out of this world
Spark plug	Showed extra spark when...
Spice	Really spiced things up
Sponge	Soaks up all the...
T Square	Squared away
Tape dispenser	Stuck to it
Tent stake	Stake in future
Top	You are tops at...
Watering can	Help the pack grow
Whale	Whale of a job
Wire whisk	Unbeatable at...
Wooden spoons, blue and gold	Blue and gold banquet chair
World globe	For the world's best...

## Pack Ceremony Equipment

The use of equipment—candleholders, boards that show ranks—adds color and life to your ceremonies. If your pack creates several different setups, you will be able to vary the ceremonies you use. Make sure that all props are:

- Easy to set up
- Easy to store (can be taken apart or folded)
- Inexpensive
- Adaptable for use in several different ceremonies
- In good working order

The items you might want to have on hand include

- A ceremonial board that holds candles or lights (up to six candles)
- An emblem for each Cub Scout rank that is large enough to be seen from the back of the room
- An artificial campfire
- A log split lengthwise with several holes drilled for candles
- Extra candles and candleholders
- A spotlight or large flashlight
- A bridge—either several poles connected with rope to suggest a bridge or pallets used to construct a bridge and railing
- Freestanding poles that hold each of the Cub Scout ranks to suggest a Cub Scout trail. These can be linked with rope.

If your location prohibits, or you prefer not to use candles, adapt the ceremonies and props to use battery-operated candles (usually available at Christmas), glow sticks, penlights, or flashlights hooded with colored cellophane. You can also replace candleholders shown on props with large outdoor Christmas lights. If you are using new candles, always light them ahead of time.

Cub Scouts love campfires. While an outdoor campfire at every pack meeting is probably too much of a good thing, you can work an artificial campfire into some of your indoor meetings, too.

Additional ideas for ceremony equipment can be found in the *Cub Scout Leader Book* and the *Cub Scout Leader How-To Book*.

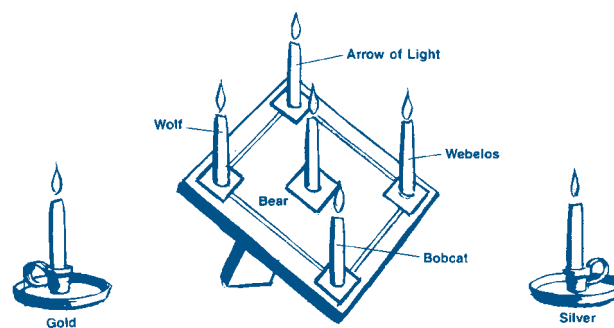

Large outdoor Christmas lights can be used to wire these props with lights to replace the candles shown.

## ADVANCEMENT LADDER

1. Ladder rungs each measure ¼-by-3-by-18 inches and are painted yellow with blue letters.
2. Uprights are 1-by-1½-by-41 inches and are painted blue. They are spaced 5 inches apart.
3. The base is 2-by-10-by-24 inches wide. The ladder is attached with 3-by-3-inch corner braces.
4. Spring-type clothespins are painted in den colors with the boy's name painted in a contrasting color.
5. The pack number can be painted on a diamond at the top of the ladder.

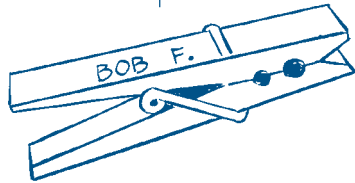
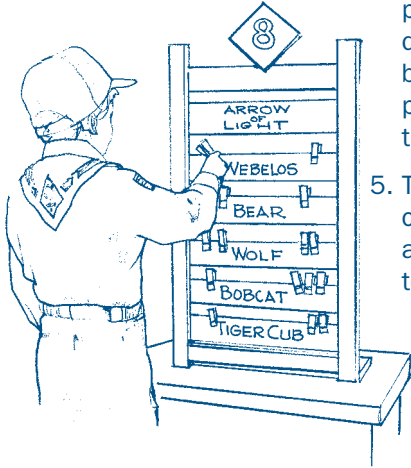

CUB SCOUT TRAIL: Mount large Cub Scout badges on freestanding holders.

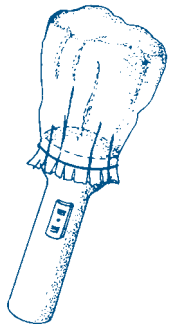
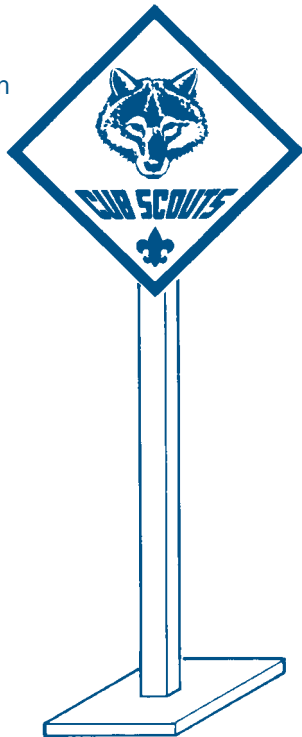

Cover flashlights with cellophane hoods to replace lighted colored candles.

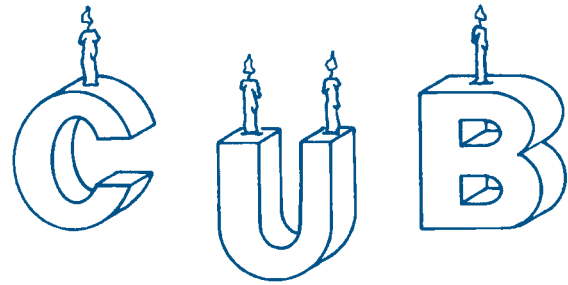

Cut simple block letters from 2-inch-thick pine. Drill holes in tops of blocks for candles or wire for lights.

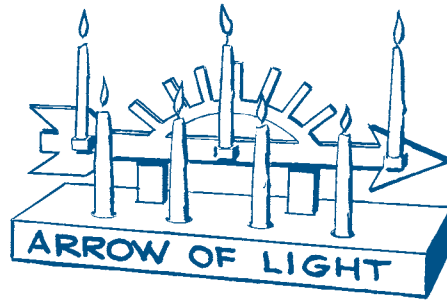

Substitute battery-operated candles or penlights as an alternative. Or use large outdoor Christmas lights with cardboard tubes to create electric candles.

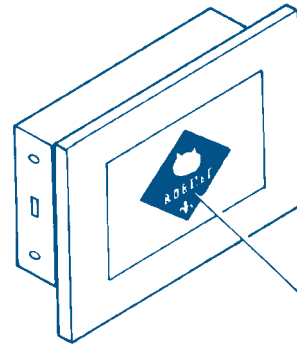

LIGHT BOX



Use a recessed lighting fixture placed on its side. Attach cutout silhouette of rank being presented.

MAGIC CANDLES can be very effective when they are used in ceremonies. As the candles burn down, they drip blue and gold wax. To make magic candles, drill ¼-inch diameter holes every 2 inches on a wide white candle. Place scrapings of blue and gold crayons in the holes (but not on top of each other). Melt paraffin and whip it with an eggbeater. Cover the candle with this whipped paraffin, using a fork to give the candle a rough decoration. Let the candle harden before handling.

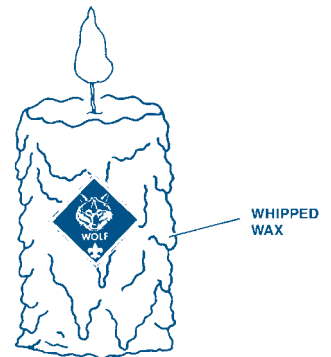

## Scouting Clip Art to Use in Ceremonies

You can use several methods to take advantage of these graphics.

- Enlarge them on a photocopier. Use marking pens to add color to your copies or print the same photo on each color needed for a badge. Cut and paste to create the final multicolored badge.
- Copy them onto a transparency and use an overhead projector to enlarge them to the desired size. Trace the design onto a paper taped on the wall.
- Mount your copies on cardboard, foam core, or wood, or laminate them for use in ceremonies. If you laminate them, you will want to spray them with a non-glare finish so they can be seen from all areas of the room without reflections from the overhead lights.
- Trace your designs onto fabric for banners and table covers.



Bobcat badge logo



Tiger Cub badge logo



Wolf badge logo



Bear badge logo



Webelos badge logo



Webelos badge logo



Arrow of Light



World Conservation Award



Compass Points Emblem



National Summertime Pack Award pin



Den Chief emblem

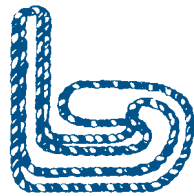

Den Chief shoulder cord



Boy Scouts of America Universal emblem



Centennial Quality Unit Award

## Music in Ceremonies

Using music in a ceremony creates an additional dimension of sound and makes the event more memorable. However, using music successfully requires additional planning, no matter what form of music is used. Always make sure that whatever source you are using, the music and lyrics are appropriate for a Cub Scout audience and exemplify the Cub Scout Promise and the positive values of Cub Scouting.

### Prerecorded Music

A wealth of music in every form, from jazz to folk and classical to rock, is available that can be adapted for ceremonies. Patriotic recordings can be used for openings and closings. Instrumental arrangements can be used as background music for advancement ceremonies. Vocal recordings can be used to lead group singing.

- Test your sound system before the day of the event to be sure it will be adequate.
- Prepare for all contingencies. Carry an extension cord, electric plug adapter, and spare batteries if necessary.
- If you are involved in the ceremony, have an assistant handle the music. Make sure your assistant knows exactly what he or she is expected to do.
- Recheck all equipment before the arrival of Cub Scouts and their families, including cueing up the music to the correct starting point as well as setting the proper volume for the group.

- If the group is to sing along with the recording, make sure the lyrics are clear and understandable and that the speed is appropriate.

### Guest Musicians

Explore your community's resources for performers who can provide live accompaniment or featured numbers. Your list might include Cub Scouts who are taking music lessons, parents, a Boy Scout troop bugler, music teachers, and staff or students from a school's music department. Their music adds a festive touch to a holiday sing-along or a blue and gold banquet. It also can add impact to special advancements and transitions.

- Make your arrangements well in advance.
- Send a written confirmation of the exact time, the location (including a map), the group size, and the name and phone number of the contact person in the pack.
- Know what equipment and setup the musicians require, such as a microphone, piano, and music stand. Be sure everything is available and in good working order before the performance date.
- If possible, arrange for a rehearsal if it is a special event.
- Contact the musicians again several days before their performance.
- Have a "plan B" in mind in case an unforeseen circumstance prevents their performance.
- Introduce the guest musicians to the group.
- Show your appreciation with some sort of token, such as a special applause and perhaps a certificate.





# CHAPTER 4

## Flag Ceremonies

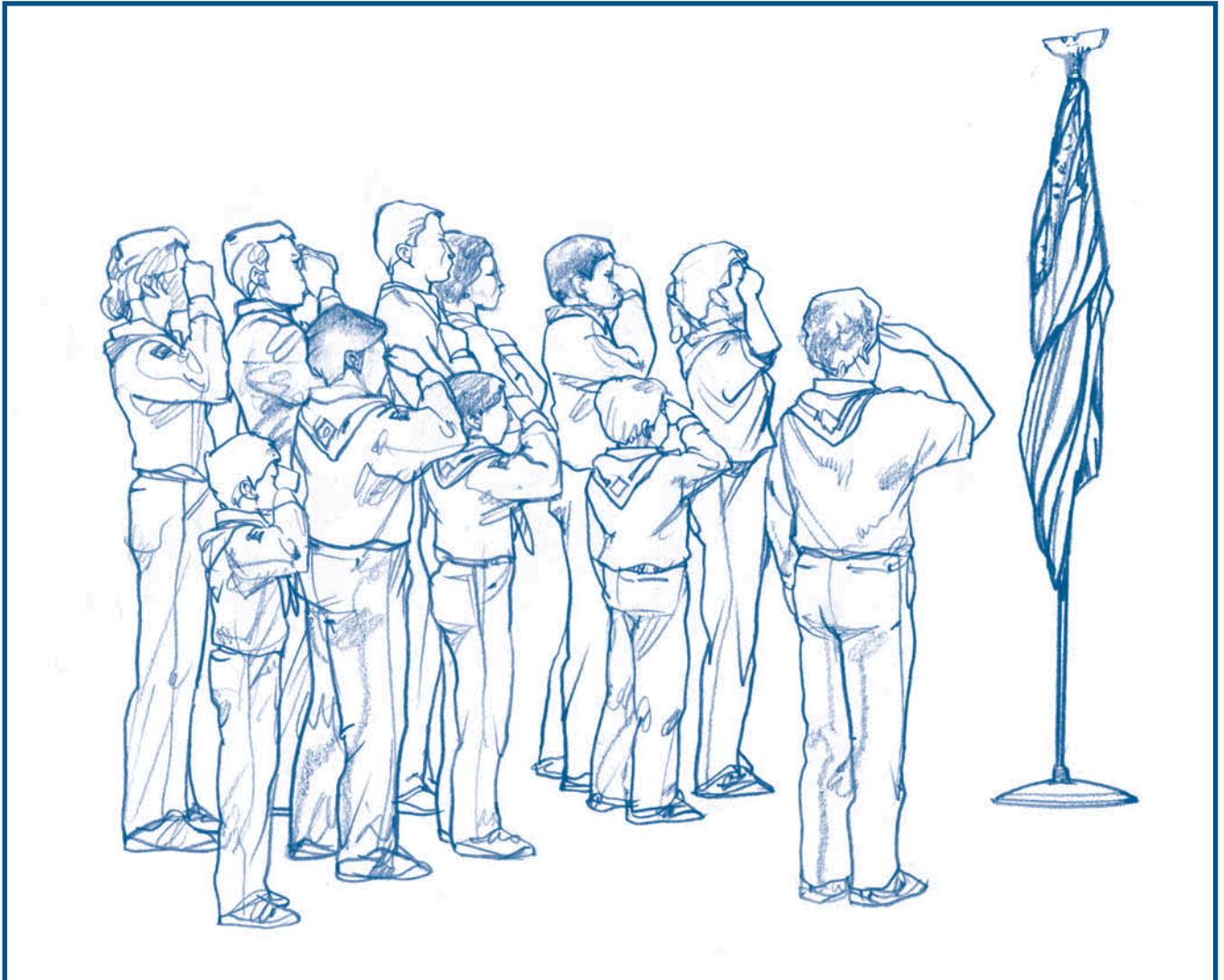

**When We Should Have Flag Ceremonies and Say the Pledge of Allegiance, 4-2**  
**Flag Ceremony Planning, 4-2**  
**Create Your Own Opening Ceremony With the U.S. Flag, 4-2**  
**Flag Ceremony Comments, 4-2**  
**Introductory Statements for the Pledge of Allegiance, 4-2**  
**Standard Indoor Flag Ceremony Using Flag Stands, 4-3**

**Standard Outdoor Flag Ceremony Using a Flagpole, 4-3**  
**Presentation of Colors—Indoors, 4-4**  
**Retiring of Colors—Indoors, 4-5**  
**Retiring Worn-Out Flags, 4-5**  
**Presentation of Colors—Flagpole, 4-6**  
**Retiring of Colors—Flagpole, 4-6**  
**Diagrams of Flag Positions, 4-7**

## When We Should Have Flag Ceremonies and Say the Pledge of Allegiance

Most den and pack meetings should include the Pledge of Allegiance to the U.S. flag. It is appropriate to have a presentation of the colors and the Pledge of Allegiance at the beginning of every pack meeting, with the retirement of the colors at the conclusion. On occasion, especially in den meetings, you can vary the opening ceremony and not use the flag. In pack meetings, you might start out with the presentation of the colors in the beginning of your pack meeting and reserve the Pledge of Allegiance for later during the opening ceremony or even during the closing ceremony. Patriotic ceremonies should be meaningful and inspirational for boys.

## Flag Ceremony Planning

When you take the time to plan ahead, the Cub Scouts will be prepared for a successful experience.

- When younger Cub Scouts are responsible for a flag ceremony, make sure the flags are not too heavy for the boys to carry.
- Check the ceiling height beforehand to determine whether the flags will clear it. If they won't, post the colors before the meeting.
- Rehearse the ceremony. Make sure everyone knows his part and walking route.

## Create Your Own Opening Ceremony With the U.S. Flag

Use the following suggestions to make your ceremony effective:

- Have the color guard post the colors and retreat. Delay the Pledge of Allegiance until after your opening ceremony.
- Post the flag, and then create a slight breeze with an electric fan.
- Shine a flashlight or spotlight on the flag.
- Follow the flag with a flashlight or spotlight while the color guard walks in.
- Use background music.
- Prerecord music and play it, making it louder or softer as your ceremony progresses.
- Use songs that are appropriate for the occasion.

“The Star-Spangled Banner”	Seasonal songs
“America, the Beautiful”	Marching songs
“You’re a Grand Old Flag”	Spiritual songs
“God Bless America”	

## Flag Ceremony Comments

Keep in mind the following guidelines:

- When in uniform, stand at attention and salute with your right hand.
- When not in uniform, stand at attention and place your right hand over your heart. You should remove your nonuniform hat.
- When in uniform, with your head covered or uncovered, either indoors or outdoors, stand at attention and salute with your right hand when the U.S. national anthem is played, the colors are raised or lowered, the Pledge of Allegiance is recited, or the U.S. flag passes by in a parade.
- The reason the color guards do not participate in saluting, singing, or saying the Pledge of Allegiance with the group is because their job is to guard the flag at all times. They should salute after the U.S. flag is posted.
- The U.S. flag is posted on the left, as you look toward the front.
- Any person can write to his or her U.S. senator or U.S. representative, and for a reasonable fee receive a flag that was flown over the U.S. Capitol in Washington, D.C.
- For more information regarding the U.S. flag, refer to the booklet *Your Flag*.
- You can find additional information on the U.S. flag from current encyclopedias and from veterans' groups.
- Make sure that you include all boys in your flag ceremonies at different times of the year. Boys with physical disabilities can proudly act as narrator or even flag bearers when adults see these events as possibilities instead of barriers.

## Introductory Statements for the Pledge of Allegiance

Often, the Pledge of Allegiance is introduced with a phrase that helps set the stage and turns our thoughts toward the meaning behind the words. Use the following ideas, but often the most effective statement is one that comes from your heart.

- Sometimes we hear people say the phrase, “One nation, (pause), under God.” When this phrase was added by House Joint Resolution 243 and approved by President Dwight D. Eisenhower on June 14, 1954, it was added without a comma or pause after the word “nation.” The correct phrasing is, “One nation under God.”
- Thirteen stripes and 50 stars—this phrase can only refer to our U.S. flag. Let us remember the history behind the Stars and Stripes as we say the Pledge of Allegiance.

- “Long may it wave”—let us remember the history of our flag as we pledge our allegiance to our flag.
- As we salute our flag, let us remember the words from the American’s Creed:
  - It is my duty to my country
  - To love it;
  - To support its Constitution;
  - To obey its laws;
  - To respect its flag; and
  - To defend it against all enemies.
- The red in our flag stands for courage and bravery. Today, as we salute our flag, let us remember the men and women in the armed forces who are serving our country and us.
- For more than 200 years, our flag has been the emblem of liberty for generation after generation of Americans. Let us look at it with pride as we pledge our allegiance to it.
- Our flag is bright with cheer, brilliant with courage, and firm with faith. Let us think about these things as we pledge our allegiance.
- We, the people—that is what our flag represents. Together, let us say the Pledge of Allegiance.
- For the opportunities our country offers to the youth of America, let us say the Pledge of Allegiance to our flag, the emblem of our nation.
- The flag is a symbol of our country. Let us join together in saluting our flag and saying the Pledge of Allegiance.
- Where our flag flies, there is freedom. Join me now in expressing our allegiance to the flag.
- On June 14, 1777, Congress approved the first official United States flag. Throughout our country, we now observe June 14 as Flag Day. Let us remember that special day as we pledge our allegiance.
- Many creative and inventive people have contributed to the growth of our country. Long ago, our ancestors never dreamed we would have automobiles, airplanes, television, computers, space shuttles, or many other things that we take for granted. It took many different people who used their individual talents to make our country grow. Let us think of these people as we pledge allegiance to our flag.
- “O beautiful for spacious skies, for amber waves of grain, for purple mountain majesties, above the fruited plain!” Our country is beautiful, from the historic treasures of New England on the East Coast, to the deep blue lakes of the Central United States, to *(add something personal about your area)*, to the towering mountains of the West. We are proud of our beautiful America and pledge ourselves to keeping it beautiful. There is beauty in each of our 50 states, and our United States flag represents those states. Stand and join me in the Pledge of Allegiance.
- America is made up of people from many different nations—including the nations of the American Indian—who have brought with them their ideals, customs, and talents. America is often called a melting pot because it is a blend of so many different people and cultures. As we pledge allegiance to our flag, let us think of all the different people who have created our country as it is today.
- Behold the emblem of our country—our flag. May it always represent the highest ideals of the American people. May its stars and stripes always support democracy in America. Stand and join me in the Pledge of Allegiance.
- We have the responsibility to care for our beautiful world. We enjoy doing things together as families. In Scouting, we have many opportunities to work and play together. Today, as we salute the flag that represents millions of American families, let us be thankful for our own families and the beautiful world in which we live. Stand and join me in the Pledge of Allegiance.
- Growing up is an adventure. Every day brings new and exciting things into our lives. Scouting opens many new doors for boys as they develop in character, personal fitness, and citizenship. As we salute the United States flag, let’s think about all the adventures that are ahead of us, and silently promise to do our best. Let us stand and pledge allegiance to our flag.

## Standard Indoor Flag Ceremony Using Flag Stands

**Preparation:** Put flag stands in place at the front of the room. Looking to the front, the U.S. flag stand is on the left. Flag guards are in the back of the room holding the flag. They have already checked to make sure that the flags fit in the flag holders and that the flags clear the ceiling.

**Personnel:** Narrator and color guard

**Materials:** U.S. flag and a pack flag

## Standard Outdoor Flag Ceremony Using a Flagpole

**Preparation:** Check the flag against the rope to make sure the attachments line up before the flag ceremony. It helps to lower the loops to the base of the flagpole so it is ready for the ceremony. Rewind the cord to hold in place.

**Personnel:** Narrator and color guard

**Materials:** U.S. flag and a pack flag

## Presentation of Colors—Indoors

Narrator	Actions
Attention. Will the audience please rise? <i>(Pause.)</i>	The color guard waits in the back of the room for the audience to stand and become quiet.
Color guard, advance.	The pack flag guards and bearer are on the left, and the U.S. flag guards and bearer are on the right. With the U.S. flag in the lead, they walk in and cross so that the U.S. flag will be on the left side of the room when you look toward the front. The bearers and guards take their positions near the flag stands, facing the audience and holding the flags vertically.
Hand salute.	Everyone, with <b>the exception of the flag bearers and guards</b> , salutes.
Please repeat with me the Pledge of Allegiance. <i>(All join in.)</i>	The bearers and guards stand at attention and continue to hold the flags. The pack flag is lowered slightly so that the U.S. flag stands taller. <b>The U.S. flag guards and bearer and pack flag guards and bearer do not salute or say the Pledge of Allegiance.</b>
Two.	The pack drops its salute. The pack flag is raised to its vertical position again.
Color guard, post the colors.	The pack flag is placed in its stand. Its guards and bearer step back into place. The U.S. flag is then posted. Its guards and bearer salute it and step back into place.
Color guard, dismissed.	The U.S. flag guard leads the procession to the back of the room with the narrator following last.

### Comments:

- When the U.S. flag is carried with another banner (such as the pack flag), it should always be on “its marching right” in the procession.
- If there is only a narrow aisle, the procession follows this order in single file: U.S. flag guard, U.S. flag bearer, pack flag bearer, pack flag guard.

## Retiring of Colors—Indoors

Narrator	Actions
Will the audience please rise? ( <i>Pause.</i> )	The color guard waits in the back of the room for the audience to rise and become quiet.
Color guard, advance.	The U.S. flag guard and bearer and pack flag guard and bearer walk down the aisle and to the flags. They stand behind the flags, facing the audience.
Color guard, salute.	The guards and bearers salute.
Color guard, retire the colors.	The U.S. flag is removed first (just slightly ahead of the pack flag).
Hand salute.	Everyone, <b>with the exception of the guards and bearers</b> , salutes. The U.S. flag stays on its “marching right” as the guards and bearers proceed down the aisle to the rear of the room.
Two.	Everyone drops the salute.

### Retiring Worn-Out Flags

As a Good Turn, Scouts can volunteer to help replace faded and tattered flags in their communities with new ones and to conduct flag retirement ceremonies for those that have been taken down. A national flag that is worn beyond repair may be burned in a fire. The ceremony should be conducted with dignity and respect, and the flag burned completely to ashes.

## Presentation of Colors—Flagpole

Narrator	Actions
Attention. Will the audience please rise. <i>(Pause.)</i>	The color guard waits in the rear for the audience to become quiet.
Color guard, advance.	The U.S. flag guards and bearer walk in and take their positions near the flagpole, facing the audience.
Color guard, prepare to raise the colors.	The line is unwound. The flag is unfolded and attached to the rope.
Hand salute.	Everyone, <b>with the exception of the U.S. flag guards and bearer</b> , salutes. Then the flag is raised quickly to the top of the pole, and the cord is wound back in place.
Color guard, raise the colors.	
Please repeat with me the Pledge of Allegiance.	The U.S. flag guards and bearer stand at attention.
<i>(All join in.)</i>	<b>The U.S. flag guards and bearer do not salute or say the Pledge of Allegiance.</b>
Two.	The pack drops its salute.
Color guard, salute.	The U.S. flag guards and bearer salute.
Color guard, dismissed.	The color guard retreats to the back of the group.

## Retiring of Colors—Flagpole

Narrator	Actions
Attention. Will the audience please rise. <i>(Pause.)</i>	The color guard waits in the rear for the audience to become quiet.
Color guard, advance.	The U.S. flag guards and bearer walk to the flagpole. They stand behind the flag, facing the audience.
Color guard, salute.	The U.S. flag guards and bearer salute.
Color guard, prepare to retire the colors.	They unwind the cord and wait.
Hand salute.	Everyone, <b>with the exception of the U.S. flag guards and bearer</b> , salutes. The U.S. flag is quickly lowered.
Two.	As soon as the flag touches the hands of the guard, this command is given. Everyone drops the salute. The U.S. flag guard and bearer remove the flag from the rope and fold it correctly.
Color guard, retreat.	They retreat to the back of the group.



# Diagrams of Flag Positions

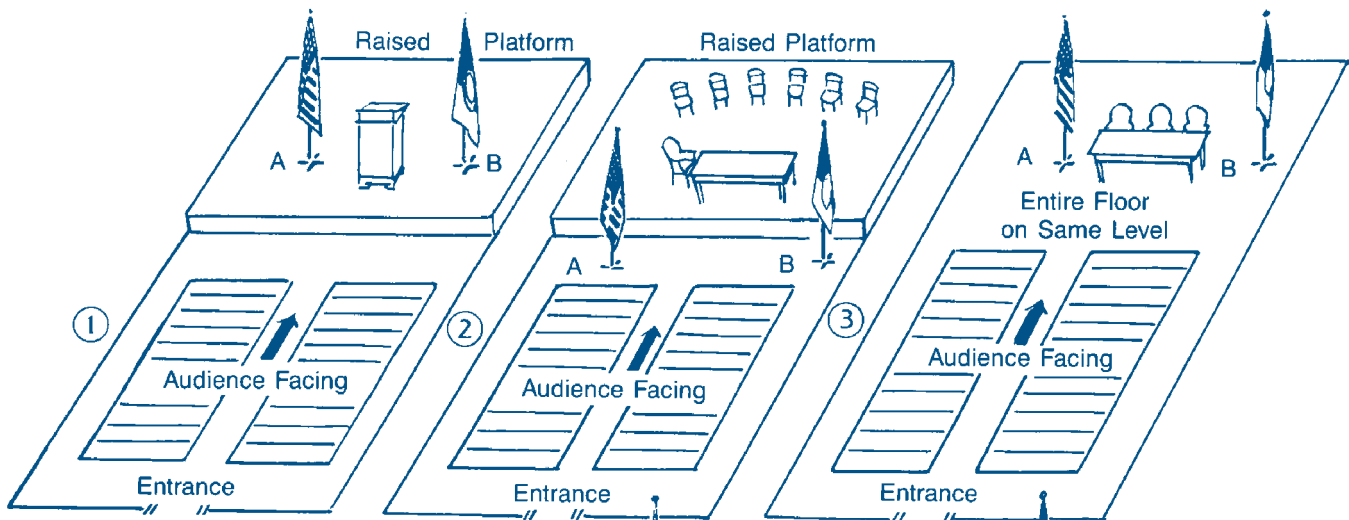

Note: **A** stands for the national flag, **B** stands for any other flag.

Diagrams 1-2-3-4 apply to lecture halls, classrooms, club rooms, churches, auditoriums, etc.

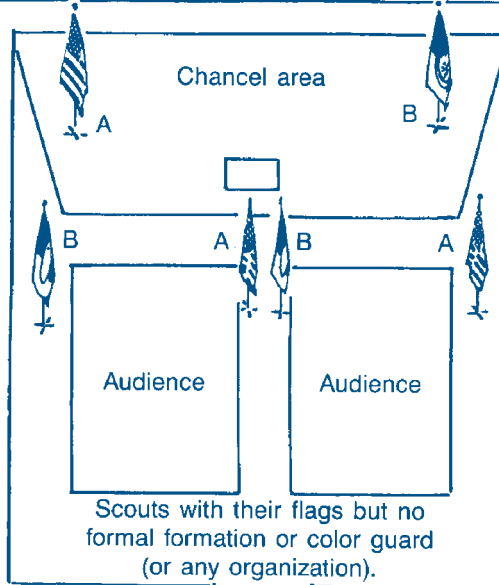
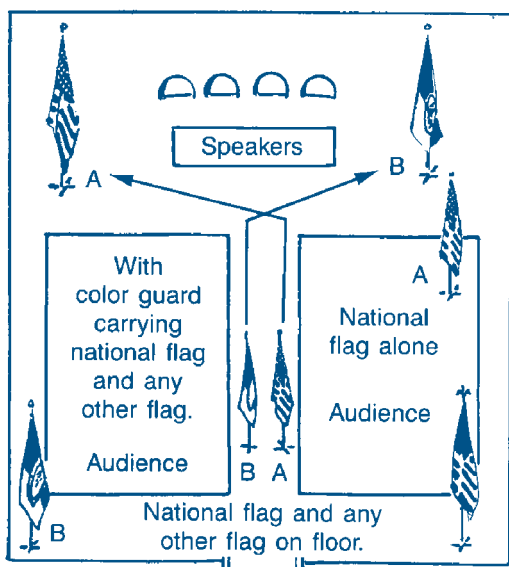
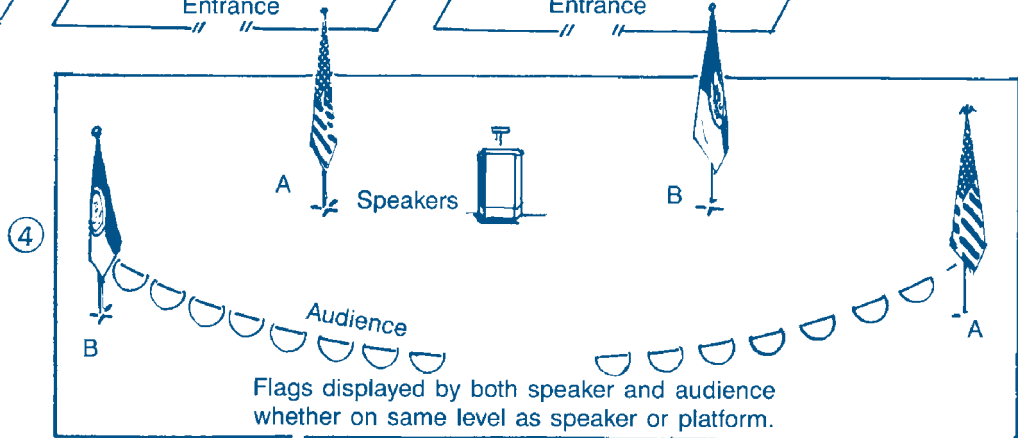



# CHAPTER 5

## Pack Meeting Opening Ceremonies



Why Are Opening Ceremonies Important? 5-2

Ceremonies

A-M-E-R-I-C-A, 5-2

America—The Song, 5-2

Building a Flag, 5-2

Discover America, 5-3

Duties as a Citizen, 5-3

Explanation of the Pledge of Allegiance, 5-3

Flag of America, 5-4

Flag Story, 5-4

I Am an American, 5-4

I Asked Myself a Question, 5-4

I Believe, 5-4

Old Glory, 5-5

Our American Heritage, 5-5

Our Country Is Different, 5-5

Our Flag, 5-5

Talking Flag, 5-6

Voting, 5-6

Achieve, 5-6

Baden-Powell, 5-6

Badges of Cloth, 5-6

What Is Tiger Cub Fun?, 5-6

Cub Scouting Is Many Things, 5-7

Cub Scout Pocket, 5-7

Cub Scout Spirit, 5-7

Fire Prevention, 5-7

Garden, 5-8

Knights, 5-8

Magic, 5-8

My Backyard, 5-8

Ships of Scouting, 5-9

Neighborhood, 5-9

Seven Seas, 5-9

Shape Up for Fitness, 5-9

Space, 5-9

Spirit of Baden-Powell, 5-10

Story of the Blue and Gold, 5-10

Woodworking, 5-10

Cub Scout Promise in Sign Language, 5-10

## Why Are Opening Ceremonies Important?

The opening ceremony at your pack meeting will set the stage for everything that follows. It can reinforce the purposes of Cub Scouting for both boys and adults. We have the opportunity to help make the Cub Scout ideals meaningful through the words and pictures of our ceremonies.

You can also use the opening ceremony to develop the Core Value being highlighted that month. You will find ideas for Core Values–related ceremonies in the *Den & Pack Meeting Resource Guide* and at Cub Scout roundtables.

Be aware of physical and/or mental disability challenges in your pack. Be sensitive to the fact that all boys and adults may not be able to, or even want to, read lines out loud. Adapt ceremonies in a sensitive way to involve everyone at the level they will feel comfortably involved.

### A-M-E-R-I-C-A

**Preparation:** Make seven cards with one letter on each: A, M, E, R, I, C, and A.

CUB SCOUT 1: A is for all people in our land.

CUB SCOUT 2: M is for the many that lent a hand.

CUB SCOUT 3: E is for equality of race, color, and creed.

CUB SCOUT 4: R is respect for all people's needs.

CUB SCOUT 5: I is for ideas—new ways to know our neighbor.

CUB SCOUT 6: C is for caring and sharing in labor.

CUB SCOUT 7: A is the allegiance we feel for our land.

CUB SCOUT 8: Stand now and pledge with heart and hand.

## America—The Song

**Preparation:** Preparing for this ceremony helps boys earn Wolf Elective 11a. The pack can sing both verses of “America” for the opening, or they can sing the first verse for the opening and the second verse for the closing.

CUB SCOUT 1: What makes our country so special?

CUB SCOUT 2: America is special because it is a land of liberty. Liberty means freedom.

CUB SCOUT 3: We can choose how we do our duty to God. We can say what we think in public. We have free education for all.

CUB SCOUT 4: We can choose our own jobs. And we have civil rights, like voting and trial by jury.

CUB SCOUT 5: A special song was written to celebrate the freedoms we have. In 1831, Samuel Smith wrote the words to “America” for a children’s Independence Day program in Boston.

CUB SCOUT 6: The first verse of the song tells of the love we have for our country because of the freedom we enjoy.

CUB SCOUT 7: The last verse is a prayer asking God to protect our free country.

CUB SCOUT 8: Stand and join us in singing “America.”

## Building a Flag

**Preparation:** Conceal a U.S. flag inside a large bowl or pot. The Cub Scouts will use a long spoon to stir the pot as they add pieces of red paper, blue paper, white paper, white stars, a needle, and some thread.

NARRATOR: Today, we have a special treat, and we’re going to follow this recipe, the greatest in the land.

First, we put in a heaping cup of red for courage. (*Cub Scout 1 puts pieces of red paper into the pot.*)

We'll add blue for truth, justice, and loyalty. (*Cub Scout 2 puts pieces of blue paper into the pot.*)

We'll also need some white for purity or cleanliness of thought, word, and deed, along with some stars. (*Cub Scout 3 pours in pieces of white paper, and Cub Scout 4 pours in white stars.*)

Finally, we'll add a needle and thread. The steel of the needle represents the strength of our nation. The thread ties us all together as Americans. (*Cub Scout 5 puts in the needle and thread.*)

When you combine these things, you come up with our flag, Old Glory. (*Cub Scouts 6 and 7 remove the flag from the pot, open and hold it.*) May it always fly with honor and respect.

## Discover America

**Materials:** Map of the United States, potato or ear of corn, silhouette of George Washington, paper, feather pen, photo of Abraham Lincoln, a kite and key, light bulb, and a photo of an astronaut

CUB SCOUT 1: (*Carrying a map of the United States.*) Many Americans helped decide our country's fate.

CUB SCOUT 2: (*Carrying a potato and/or an ear of corn.*) Our native people developed plants that we still use for food and in medicines today.

CUB SCOUT 3: (*Carrying a silhouette of George Washington.*) As our first president, George Washington was great.

CUB SCOUT 4: (*Carrying parchment and a quill pen or feather.*) The Declaration of Independence, Thomas Jefferson did write.

CUB SCOUT 5: (*Carrying a picture of Abraham Lincoln.*) Abraham Lincoln freed the slaves after a terrible fight.

CUB SCOUT 6: (*Carrying the kite and key.*) Benjamin Franklin shared many ideas bright.

CUB SCOUT 7: (*Carrying a light bulb.*) Thomas Edison invented the electric light.

CUB SCOUT 8: (*Carrying a photo of an astronaut.*) Eagle Scout Neil Armstrong placed on the moon our own red, white, and blue.

CUB SCOUT 1: Stand and renew our Pledge of Allegiance so true.

## Duties as a Citizen

**Preparation:** Create a large poster with the Citizenship Pledge written on it or hand out individual copies of the pledge to each person as everyone arrives at the pack meeting.

CUB SCOUT 1: As citizens of the United States, we have duties that we must fulfill.

CUB SCOUT 2: As a citizen, it is my duty to obey the laws.

CUB SCOUT 3: As a citizen, it is my duty to respect the rights of others.

CUB SCOUT 4: As a citizen, it is my duty to stay informed on issues of local and national government.

CUB SCOUT 5: As a citizen, it is my duty to vote in elections.

CUB SCOUT 6: As a citizen, it is my duty to serve and defend my country.

CUB SCOUT 7: As a citizen, it is my duty to assist law enforcement agencies.

CUB SCOUT 8: As a citizen, it is my duty to practice and teach good citizenship in my home. Please read the Citizenship Pledge with me. (*All join in.*)

As citizens, we will do our best  
to be prepared in body and will,  
in spirit and skill.

We accept our obligation to God  
and will show by our actions  
we are willing to serve others  
and be good members of the Scouting team.

## Explanation of the Pledge of Allegiance

**Preparation:** Cub Scouts memorize lines to recite from the Pledge of Allegiance.

NARRATOR: We often recite the Pledge of Allegiance without really listening to or understanding the words we are saying. We will recite it and talk about the meaning of each phrase.

CUB SCOUT 1: I pledge allegiance...

NARRATOR: I, an individual, promise my love, devotion, and loyalty.

CUB SCOUT 2: To the flag of the United States of America...

NARRATOR: It is the symbol of 50 great states that have a common bond.

CUB SCOUT 3: And to the republic for which it stands...

NARRATOR: Representatives are chosen by the people to govern themselves in a republic.

CUB SCOUT 4: One nation under God...

NARRATOR: We are one nation under God and blessed by God. There is no pause after nation. It is said as one complete phrase—one nation under God.

CUB SCOUT 5: Indivisible...



NARRATOR: It is incapable of being divided.

CUB SCOUT 6: With liberty...

NARRATOR: With freedom and the right to live your own life the way you wish.

CUB SCOUT 7: And justice...

NARRATOR: Dealing fairly with others.

CUB SCOUT 8: For all.

NARRATOR: Everyone—it is your country as much as it is mine. Please stand and repeat the Pledge of Allegiance with us.

## Flag of America

**Preparation:** In a darkened room, the first three Cub Scouts light three candles or turn on three lights, one red, one white, and one blue candle, in turn as they speak their lines. The fourth boy turns toward the U.S. flag as he speaks.

CUB SCOUT 1: (*Lights red candle.*) The red of our flag stands for the courage to stand up for what we believe.

CUB SCOUT 2: (*Lights white candle.*) The white of our flag stands for cleanliness of thought, word, and deed.

CUB SCOUT 3: (*Lights blue candle.*) The blue of our flag stands for truth and justice like the blue of the skies.

CUB SCOUT 4: (*Turns toward the U.S. flag.*) Our flag, the flag of America, where people of all races and beliefs can live together in peace and friendship.

## Flag Story

**Preparation:** Dim the lights as the last speaker finishes and have two boys shine flashlights on the flag.

CUB SCOUT 1: On September 13, 1814, the British began shooting at Fort McHenry, outside the city of Baltimore, Maryland.

CUB SCOUT 2: They were holding an American prisoner on board a warship until they finished their attack.

CUB SCOUT 3: Through the night, the American paced the deck as he watched the battle, not knowing whether the fort could hold.

CUB SCOUT 4: The next morning, the haze was so thick that he couldn't tell whether the battle had been won or lost.

CUB SCOUT 5: Suddenly, a clearing in the mist gave him a glimpse of the U.S. flag still flying over the fort.

CUB SCOUT 6: Francis Scott Key was so excited he wrote a poem that is now our national anthem.

CUB SCOUT 7: Please rise and join us in singing "The Star-Spangled Banner."

## I Am an American

CUB SCOUT 1: My country gives me the opportunity to be anything I want to be. I am an American.

CUB SCOUT 2: My country means love of freedom, faith in democracy, justice, and equality. I am an American.

CUB SCOUT 3: My country believes in the worth of every person. I am an American.

CUB SCOUT 4: My country gives us the privilege of saying what we believe. I am an American.

CUB SCOUT 5: My country is a democracy, and I have a duty to keep it that way. I am an American.

CUB SCOUT 6: My country promises life, liberty, and the pursuit of happiness. I am an American.

CUB SCOUT 7: My country is one that we should protect and defend. I am an American.

CUB SCOUT 8: My country is the land of the free and the home of the brave. I am an American.

## I Asked Myself a Question

NARRATOR: I asked myself a question today. What does it mean to be an American? I decided that being an American means that I have many freedoms. What are they?

CUB SCOUT 1: Freedom to think, and to say out loud what I think.

CUB SCOUT 2: Freedom to worship as I please.

CUB SCOUT 3: Freedom to move about.

CUB SCOUT 4: Freedom to try, and freedom to fail.

CUB SCOUT 5: Freedom to stand up straight and look the world in the eye.

CUB SCOUT 6: Freedom from want, and freedom from fear.

NARRATOR: These freedoms were here long before we were born. I have four guarantees that they will remain: the Declaration of Independence, the U.S. Constitution, my fellow Americans, and myself. No one could ask for more.

## I Believe

**Preparation:** Create a poster with the words of "God Bless America" written large enough for everyone to read. Or pass out individual copies of the words to each person as everyone arrives at the pack meeting.

CUB SCOUT 1: I believe in America!

CUB SCOUT 2: I believe in this country where freedom is more than just a word.

CUB SCOUT 3: I believe that as a nation we place our trust in God.



CUB SCOUT 4: I believe that as a country, we have our faults but also try to overcome them.

CUB SCOUT 5: I believe in America!

CUB SCOUT 6: Please stand and join us in singing “God Bless America.”

## Old Glory

**Preparation:** The U.S. flag is already posted. Four Cub Scouts hold flashlights that shine on it.

NARRATOR: What you see here represents the past, the present, and the future. The stripes of Old Glory stand for the original 13 colonies. The stars represent the 50 states. The boys represent the men of tomorrow. The lights remind us of four great freedoms.

CUB SCOUT 1: Freedom of speech

CUB SCOUT 2: Freedom of worship

CUB SCOUT 3: Freedom from want

CUB SCOUT 4: Freedom from fear

NARRATOR: Let us all stand and pledge allegiance to our flag.

### Alternative staging for the above ceremony:

In a dimly lit room, have four Cub Scouts each hold a corner of the U.S. flag in one hand, and a flashlight in the other hand. The boys turn on their flashlights, and the narrator starts reading.

NARRATOR: What you see here represents the past, the present, and the future. The stripes of Old Glory stand for the original 13 colonies. The stars represent the 50 states. The boys represent the men of tomorrow. The lights remind us of four great freedoms: freedom of speech, freedom of worship, freedom from want, and freedom from fear. Eliminate any one of these freedoms and our world becomes darker and colder. *(At this time, the boys turn off their flashlights one by one as the narrator repeats.)* Freedom of speech... freedom of worship... freedom from want... freedom from fear. *(As the fourth flashlight is turned off, the room lights are turned off. The two boys holding the lower corners of the flag drop them and move to the front of the flag, face it, and salute before the room lights are turned back on.)*

NARRATOR: In a world where these four freedoms struggle to stay alive, there is a country where they flourish. Let us all stand and pledge our love to our country by singing “God Bless America.”

## Our American Heritage

CUB SCOUT 1: I am the symbol of America.

CUB SCOUT 2: I am life, liberty, and the right to pursue happiness.

CUB SCOUT 3: I am hope for each person to be what he or she wants to be.

CUB SCOUT 4: I am life and stand for each person who died so I could live in freedom.

CUB SCOUT 5: I am tolerance so all people can worship God in the way they wish.

CUB SCOUT 6: I am a sign of the future as I wave over schools and government buildings.

CUB SCOUT 7: I am the flag of the United States.

## Our Country Is Different

CUB SCOUT 1: Our country is great in different ways. We would like to tell you some of the things that are different and that help make it great.

CUB SCOUT 2: We call it the United States, and we are bound together by the Constitution, but in many ways we are a group of separate nations.

CUB SCOUT 3: We practice more than 250 religions and observe thousands of different laws.

CUB SCOUT 4: Our land grows palm trees and pine trees, redwoods and birch.

CUB SCOUT 5: We catch shrimp and sell stocks; we live in small towns and large cities and in the rural countryside.

CUB SCOUT 6: We are a very diverse people, and this is what makes the United States great.

CUB SCOUT 7: Let us rise and sing “America, the Beautiful.”

## Our Flag

**Preparation:** Use an unseen narrator or have someone tape the following narrative in advance. Spotlight the U.S. flag and darken the room.

NARRATOR: I am Old Glory. For more than 200 years I have been the banner of hope and freedom, for generation after generation of Americans. Born amid the first flames of America’s fight for freedom, I am the symbol of a country that has grown from a little group of 13 colonies to a nation of 50 states. Over the years, my stars and stripes have proved an inspiration to untold millions of Americans, including those who have followed me into battle with unwavering courage. They have looked upon me as a symbol of national unity. They have prayed that they and their fellow citizens might continue to enjoy the life, liberty, and pursuit of happiness that have been promised to every American. As long as Americans cherish liberty more than life itself, as long as they treasure the privileges bought so dearly, as long as the principles of truth, justice, and liberty for all remain deeply rooted in their hearts, I shall continue to stand for the United States of America. I am Old Glory.

## Talking Flag

**Preparation:** Have the U.S. flag posted in a flag stand in the center of the room. Dim the lights and spotlight the flag. Have a person out of view and place a small speaker near the flag. A Cub Scout walks by the flag as it begins speaking. An alternate plan is to record the speaking part of the flag in advance and place a small tape player near the flag.

FLAG: Hello, Scout!

CUB SCOUT: Did you talk to me?

FLAG: I've been speaking since back in 1776, to anyone who would listen. My story is simple. Would you like to hear it?

CUB SCOUT: Yes! (*He sits down on the floor.*)

FLAG: When our country became a new nation, I had 13 stripes and a circle of 13 stars on a field of blue. Then in 1794, I had 15 stars and 15 stripes. I was called the Star-Spangled Banner when Francis Scott Key wrote a poem about me in 1814. This poem became our National Anthem. In 1818, the stripes were changed back to the original 13, and from then on, a star was added for each new state that joined our union. That is why there are 50 stars on me.

CUB SCOUT: (*Stands.*) That's great. Let's all stand and say the Pledge of Allegiance.

## Voting

NARRATOR: Tonight we'll talk about our freedoms. Our nation has remained strong and free because our government is of the people, by the people, and for the people. Each of us has an obligation to do all that we can to preserve the freedoms for which thousands of our ancestors have died. Here are the freedoms guaranteed to us in our Constitution.

CUB SCOUT 1: The right to worship God in one's own personal way.

CUB SCOUT 2: The right to free speech and press.

CUB SCOUT 3: The right to assemble peaceably.

CUB SCOUT 4: The right to petition for a redress of grievances.

CUB SCOUT 5: The right to privacy in our homes.

CUB SCOUT 6: The right to protection against illegal imprisonment and the freedom from excessive bail.

CUB SCOUT 7: The right to trial by jury. A person is innocent until proved guilty.

CUB SCOUT 8: The right to move about freely at home and to travel abroad.

CUB SCOUT 1: The right to own property.

CUB SCOUT 2: The right to a free election and a personal secret ballot.

NARRATOR: Maintaining our freedoms is the responsibility of every American. Keep your freedom. Vote as you think, but vote.

## Achieve

**Preparation:** Make seven large cards with one of the letters of "ACHIEVE" written on one side and its corresponding script written on the other.

CUB SCOUT 1: A is for advancement along the Scouting trail.

CUB SCOUT 2: C is for commitment to always do your best.

CUB SCOUT 3: H is for home, where it all begins.

CUB SCOUT 4: I is for the individual who is learning teamwork.

CUB SCOUT 5: E is for everyone—the den works together.

CUB SCOUT 6: V is for victory that is achieved along the trail.

CUB SCOUT 7: E is for excellence, a job well done.

## Baden-Powell

NARRATOR: In 1907, Baden-Powell took 21 boys with him to Brownsea Island, off England's southern coast, for what was to be the world's first Scout camp. It was successful beyond his wildest dreams. Because of this beginning, Scouting was organized in America and in many other countries. Today, there are more than 28 million Scouts and Scouters from 160 countries around the world. Time changes many things, but the aims of Scouting are the same today as when it was started. Please stand, give the Cub Scout sign, and say the Cub Scout Promise.

## Badges of Cloth

**Preparation:** Make six cards with the letters B, A, D, G, E, and S for the boys to hold.

CUB SCOUT 1: B stands for badges that are made from cloth.

CUB SCOUT 2: A stands for Akela—my family and leaders who help me.

CUB SCOUT 3: D stands for "Do my best."

CUB SCOUT 4: G stands for grow. The pack helps the Cub Scout grow.

CUB SCOUT 5: E stands for eagerness and energy that are needed to earn badges.

CUB SCOUT 6: S stands for service to others.

All: BADGES!

## What Is Tiger Cub Fun?

**Preparation:** Tiger Cubs hold cards with a letter on one side and script on the back. The Tiger Cub says a letter, and then his adult partner reads the script.

TIGER CUB DEN LEADER: What is Tiger Cub fun?

TEAM 1: T—Trying new activities with our families and den.

TEAM 2: I—Identifying what makes our families special.

TEAM 3: G—Getting to know others and ourselves better.

TEAM 4: E—Exploring our town and the world around us.

TEAM 5: R—Reinforcing values taught at home.

TEAM 6: S—Searching, discovering, and sharing new adventures and ideas.

## Cub Scouting Is Many Things

NARRATOR: Cub Scouting is many things.

CUB SCOUT 1: Cub Scouting is a boy.

CUB SCOUT 2: Cub Scouting is a family that cares about this boy.

CUB SCOUT 3: Cub Scouting is a den leader who works with a den.

CUB SCOUT 4: Cub Scouting is a den chief who is the best example there could be.

CUB SCOUT 5: Cub Scouting is a Cubmaster and pack committee who lead our pack.

CUB SCOUT 6: Cub Scouting is building character while having fun.

CUB SCOUT 7: Cub Scouting is citizenship, learning respect for God and country.

CUB SCOUT 8: Cub Scouting is learning about fitness and teamwork and always doing your best.

NARRATOR: As you can see, Cub Scouting is many things—each one is important. This is Cub Scouting.

## Cub Scout Pocket

**Preparation:** Prepare two pockets out of cardboard—one blue and one tan (or two blue). Make or buy large emblems (Bobcat, Tiger Cub, Wolf, Bear, Webelos, Arrow of Light, and Gold and Silver Arrow Points).

NARRATOR: This is a pocket—a very plain pocket that could belong to anyone. (*Cub Scout 1 places a Bobcat badge on the blue pocket.*)

Now, our pocket is turning into something with meaning. It represents a sense of belonging and will soon hold our Cub Scout knowledge, skills, and fellowship. (*Cub Scout 2 places a Tiger Cub badge on the pocket, Cub Scout 3 places a Wolf badge on the pocket, and Cub Scout 4 places Gold and Silver Arrow Points below the pocket.*)

Before too long, our pocket becomes even more special. It proudly displays newfound knowledge of our flag, knowledge about keeping ourselves strong, about tools, knots, safety, books, and reading. It means our Cub Scout has mastered feats of skill and has shown his willingness

to help in his home and take part in family fun. (*Cub Scout 5 places a Bear badge on the pocket, and Cub Scout 6 places Gold and Silver Arrow Points below the pocket.*)

Our pocket now has even more meaning. It shows our Cub Scout is completing increasingly difficult achievements that show he is growing in knowledge and skill.

(*Cub Scout 7 places a Webelos badge on the tan [or second blue] pocket, and Cub Scout 8 places an Arrow of Light Award below the pocket.*)

Our pockets now show that our Cub Scout has learned hobbies and career-related skills. He has also learned what it means to be a Boy Scout.

Cub Scouting has turned our plain pocket into a pocketful of adventure, fun, and excitement.

## Cub Scout Spirit

**Preparation:** Set up four candles or lights.

NARRATOR: Scouts and leaders, we are following a trail blazed by millions of boys, men, and women. All of them have had that Scouting spirit, which the flame of this light represents (*lights first candle or light*).

CUB SCOUT 1: What is Cub Scout spirit?

CUB SCOUT 2: It is the three things we promise to do in the Cub Scout Promise.

CUB SCOUT 3: The first part is, “I promise to do my best to do my duty to God and my country.” (*Lights next light.*)

CUB SCOUT 4: The second part is “to help other people.” (*Lights next light.*)

CUB SCOUT 5: The third is “to obey the Law of the Pack.” (*Lights last light.*)

CUB SCOUT 6: While these lights burn, please stand and say the Cub Scout Promise.

## Fire Prevention

**Preparation:** Dim the lights in room. One Cub Scout lights a single white candle or light in the front of the room.

NARRATOR: Scouts, this light represents the spirit of Scouting, lighting our way through life. But the flame also represents danger. This month we have learned about the dangers of fire and how to prevent fires. Let’s remember what we have learned so that we will always use fire safely and wisely not only as boys, but later on as men.

This light of Scouting gives us warmth and good cheer. Make sure it is never allowed to run wild and destroy lives and property.

We will let the light of Scouting burn throughout our meeting to remind us of our ideals.

## Garden

**Preparation:** Each Cub Scout carries a poster with a picture of each vegetable mentioned, poster board decorated as seed packages, or real vegetables. For younger boys who have trouble with the words, have an adult read the entire script and let the boys walk on with the items.

CUB SCOUT 1: Here is how to plant one of those thriving Scout gardens that every family wants to grow.

CUB SCOUT 2: First, plant rows of peas—preparedness, promptness, perseverance, politeness, and praise.

CUB SCOUT 3: Then plant rows of lettuce—let us work together, let us be unselfish, let us be loyal, let us be truthful, let us help one another.

CUB SCOUT 4: Next to them plant rows of squash—squash prejudice, squash impatience, squash indifference.

CUB SCOUT 5: No garden is complete without turnips—turn up for den and pack meetings, turn up with new ideas, turn up with determination.

CUB SCOUT 6: Without the help of every family and boy in our pack, our Scouting garden will turn to weeds.

CUB SCOUT 7: So help us work the soil, pull the weeds, and spread the sunshine so we can say, “We have done our best.”

## Knights

**Preparation:** Create a large shield. Give each boy who has a speaking part the appropriate badge to place on the shield. As the narrator finishes the script, the color guard posts the U.S. flag.

**Materials:** Shield; BSA logo; Cub Scout rank emblems: Bobcat, Tiger Cub, Wolf, Bear, Arrow Point, Webelos, Arrow of Light logos; religious emblem; and a U.S. flag

NARRATOR: Hear ye, hear ye! Tonight we speak of the days of yore when a coat of arms was really important. It told all who met you, who your family was, and whether you were a friend. Today, we wear our coat of arms—our Cub Scout uniform.

CUB SCOUT 1: The first Scouting insignia tells everyone that we belong to the worldwide family of Scouting. *(He places the Scouting emblem on the shield.)*

CUB SCOUT 2: The Bobcat is the first badge we earn. It means we have learned the basic rules of Cub Scouting. *(He places the Bobcat badge on the shield.)*

CUB SCOUT 3: The Tiger Cub badge is next for first-graders. Boys learn how to build strong relationships with one another and their families. *(He places the Tiger Cub badge on the shield.)*

CUB SCOUT 4: Cub Scouts who are 8 years old or in the second grade earn the Wolf badge. While working toward it, we learn respect for our flag, about home safety, and about our neighborhood. *(He places the Wolf badge on the shield.)*

CUB SCOUT 5: Next we move on to our Bear badge. Conservation, folklore, and woodworking are some of the fields we explore. *(He places the Bear badge on the shield.)*

CUB SCOUT 6: While advancing through the Wolf and Bear ranks, we can choose to do extra projects and earn Arrow Points. *(He places the Arrow Point emblems on the shield.)*

CUB SCOUT 7: Our next step is Webelos, where we work on activity badges such as Citizen, Artist, Engineer, and Forester. *(He places the Webelos badge on the shield.)*

CUB SCOUT 8: The Arrow of Light is the highest award in Cub Scouting. It means that we have worked on additional activity areas and have learned the basics about Boy Scouting. *(He places the Arrow of Light emblem on the shield.)*

CUB SCOUT 9: Many Cub Scouts also earn the religious emblem for their faith. They have explored and learned what their religion means to them and their community. *(He places the religious emblem or knot on the shield.)*

NARRATOR: To complete our coat of arms, we include the U.S. flag. It symbolizes our country and the love and respect we have for it. Our flag tells everyone we are proud to be Americans. Let us stand and salute our flag. *(The color guard brings in the U.S. flag.)*

## Magic

**Preparation:** Make five large cards with the letters M, A, G, I, and C on them.

CUB SCOUT 1: We'd like to tell you about the magic we call Scouting.

CUB SCOUT 2: M is for the memories you'll make with your families in Scouting.

CUB SCOUT 3: A is for advancement. Learning new skills is a big part of the sharing time for Scouts and families.

CUB SCOUT 4: G is for goodwill. Giving goodwill teaches us to share and help others.

CUB SCOUT 5: I is for important, which describes the time we spend with our families in great activities.

CUB SCOUT 6: C is for communication. This is the key to understanding and respect within a family.

ALL: Scouting is magic!

## My Backyard

CUB SCOUT 1: My backyard is a wonderful place, where I can discover my own special space.

CUB SCOUT 2: I can pitch a tent and sleep in the rain, or listen to the whistle of a faraway train.

CUB SCOUT 3: I can throw a ball, if one is to be had. Or just be alone when I get mad.



CUB SCOUT 4: I can plant a garden or climb a tree, or watch my dog chase a bumblebee.

CUB SCOUT 5: Sometimes we even have den meetings there. I've finished my Wolf badge and started my Bear badge.

CUB SCOUT 6: Yeah, the backyard is where I run, when I really want to have some fun.

## **Ships of Scouting**

**Preparation:** Make six large cutout silhouettes of ships. Print the following words, one word per silhouette, on them: SCHOLAR-SHIP, FELLOW-SHIP, FRIEND-SHIP, SPORTSMAN-SHIP, WORKMAN-SHIP, STATESMAN-SHIP

CUB SCOUT 1: We would like to tell you about the six ships of Scouting.

CUB SCOUT 2: Scholarship is very important on the sea of education.

CUB SCOUT 3: Fellowship stands for cooperation and unity.

CUB SCOUT 4: Friendship is the most beautiful ship of all. It is true blue, and its flag is golden.

CUB SCOUT 5: Sportsmanship stands for all that is fair.

CUB SCOUT 6: Workmanship represents the best that a person can give.

CUB SCOUT 7: Statesmanship represents wise guidance and unselfish interest.

CUB SCOUT 8: These six strong and sturdy ships will help you brave the sea of life. Three cheers for the Scouting ships!

## **Neighborhood**

**Preparation:** Have five Cub Scouts ready to walk on in turn carrying their item, a newspaper, envelope, stop sign poster, 25-mph sign, or recycling item.

CUB SCOUT 1: (*carrying newspaper*) I'm your paper-boy—I deliver the news. Freedom of press has different views.

CUB SCOUT 2: (*carrying envelope*) I'm the postman—I deliver with dash. That new *Boys' Life* is really a smash.

CUB SCOUT 3: (*carrying stop sign poster*) Safety is my job; I'm the school crossing guard. You cross the street safely to get to your yard.

CUB SCOUT 4: (*carrying 25-mph sign*) I'm the speed limit sign, which saves lots of lives. People obey me, during their drive.

CUB SCOUT 5: (*carrying recycling item*) I'm the litter, which makes everyone bitter. Let's recycle it, so life will be better.

NARRATOR: Our neighborhood is an important part of the country in which we live.

## **Seven Seas**

**Preparation:** Have seven Cub Scouts stand with candles or flashlights behind the narrator.

NARRATOR: The seven lights you see here represent the seven seas and the seven continents from which our ancestors came to this great land. Our Statue of Liberty has seven spikes coming from her crown to represent the same seas and continents. Let's give thanks to our God who guided all of us here. (*Pause.*) Now please stand and join us in singing "America, the Beautiful."

## **Shape Up for Fitness**

**Preparation:** Make large cards with the letters S, H, A, P, E, U, and P on them.

CUB SCOUT 1: S—Shaping up is what we have been doing this month.

CUB SCOUT 2: H—Hard as we do our exercises,

CUB SCOUT 3: A—Athletic and fit as we can be,

CUB SCOUT 4: P—Push-ups, curl-ups, 1-2-3,

CUB SCOUT 5: E—Takes all the energy

CUB SCOUT 6: U—Under the sun

CUB SCOUT 7: P—To make an awesome person like me.

ALL: Shape up!

## **Space**

**Preparation:** Make cards with the letters C, U, B, S, C, O, U, and T on them. Shape the first and last card so that when all are put together, they form a spaceship that moves off-stage when the narrator says the final, "Blast off!"

NARRATOR: We're going to assemble our rocket for a trip into space, and we'd like you to join us.

CUB SCOUT 1: C stands for for courtesy all through life.

CUB SCOUT 2: U stands for usefulness to our families and others.

CUB SCOUT 3: B stands for bravery in thought and deed.

CUB SCOUT 4: S stands for safety in all that we do.

CUB SCOUT 5: C stands for choice. We worship God in the way we choose.

CUB SCOUT 6: O stands for outdoors and the beauty of nature.

CUB SCOUT 7: U stands for unity—in our family, our den, our pack.

CUB SCOUT 8: T stands for the truth in all things.

NARRATOR: Now we are ready to blast off. 5-4-3-2-1... BLAST OFF! (*The rocket moves off stage.*)

## Spirit of Baden-Powell

**Preparation:** Cub Scouts bring in a different symbol for each statement the narrator makes before the color guard enters: a religious symbol or emblem, a boy in complete uniform, a *Wolf Handbook*, a craft project, an object from nature, a U.S. flag, and the pack flag.

NARRATOR: I represent the spirit of Baden-Powell—the founder of Scouting.

*(Cub Scout 1 enters carrying a religious symbol or religious emblem.)* Religious organizations sponsor almost half the Cub Scout packs in America.

*(Cub Scout 2 walks in wearing a complete uniform.)* The two colors of the Cub Scout uniform have a meaning: Blue stands for truth and loyalty, gold for good cheer and happiness.

*(Cub Scout 3 carries a Wolf Handbook.)* Cub Scouting was based on Rudyard Kipling’s *Jungle Book*.

*(Cub Scout 4 carries a craft project.)* We have lots of fun making things.

*(Cub Scout 5 carries something from nature.)* We also like to hike and enjoy the outdoors.

We learn about citizenship. Scouts are the men of tomorrow. Please stand. *(A color guard enters carrying a U.S. flag and the pack flag.)* Please join us in singing “God Bless America.”

## Story of the Blue and Gold

**Preparation:** Put a large pot on a table with an inner pot containing dry ice. A blue and gold Wolf Cub Scout neckerchief is concealed in the area between the large pot and the inner pot. Have two clear jars concealed elsewhere in the room with blue- and yellow-colored water in them. Two Cub Scouts stand with the narrator.

NARRATOR: Many, many years ago, an elder gave two trusted young men a challenge. He told the first young man to climb the mountain and ask the great eagle to fly high into the sky. His mission was to bring back part of the beauty of the sun. *(The first Cub Scout leaves.)*

He told the second young man to go into the forest and tell the sparrow to fly into the sky and bring back part of the sky. *(The second Cub Scout leaves. Then both boys return—one carrying a bottle of yellow-colored water and the second carrying a bottle of blue-colored water. They hold them up for everyone to see.)*

*(To the first boy.)* Pour some of the beauty of the sun into our mixing pot. *(The boy carefully pours the yellow liquid over the dry ice.)*

*(To the second boy.)* Pour some of the beauty of the sky into our mixing pot. *(The second boy carefully pours his blue water into the pot.)*

*(To the pack.)* From this day forward, blue will stand for truth and loyalty. Yellow will stand for warm sunshine, happiness, and good cheer. *(Reaches into the pot, removes the blue and gold Wolf Cub Scout neckerchief and opens it for everyone to see.)* And that is why Cub Scouts use the colors blue and gold.

## Woodworking

**Preparation:** Gather tools—an awl, chisel, level, file, drill, hammer—and a piece of wood for speakers to hold. Use a U.S. flag in a stand.

CUB SCOUT 1: “Awl” Scouts should remember the motto: Do Your Best.

CUB SCOUT 2: Scouting “chisels” out a well-rounded program for families.

CUB SCOUT 3: In Scouting, boys work on projects that are appropriate to their age “level.”

CUB SCOUT 4: Scouting helps to “file” the rough edges off boys and smooths their way.

CUB SCOUT 5: The Cub Scout Promise helps to “drill” into boys a sense of duty to God and country and helping others.

CUB SCOUT 6: All families can “hammer” out the responsibilities of our pack by volunteering to help in their own way.

CUB SCOUT 7: “Wood” everyone now please stand and repeat the Pledge of Allegiance?

## Cub Scout Promise in Sign Language

**Preparation:** When a den practices this in advance, it is a beautiful ceremony. You may want to dim the lights and spotlight the den standing in front of the pack. Have the boys in the den demonstrate the Cub Scout Promise in sign language one time through and then have the pack join them, step by step.



# Cub Scout Promise in Sign Language



I

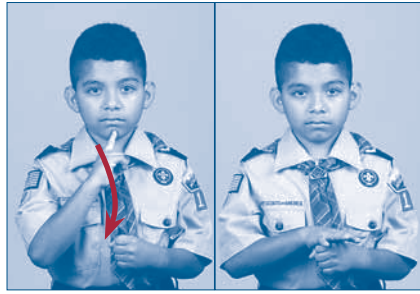

Promise



To

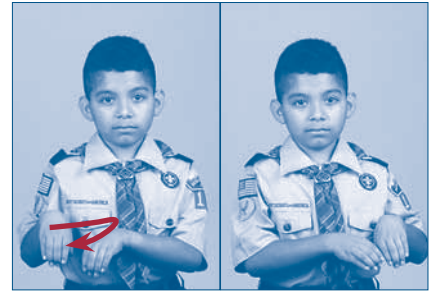

Do



My



Best



To

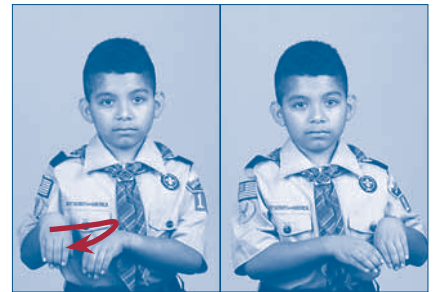

Do



My



Duty



To

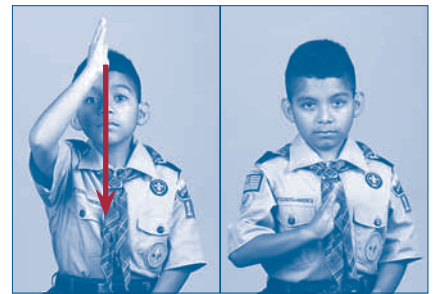

God



And



My



Country



To



Help



Other



People



And



To

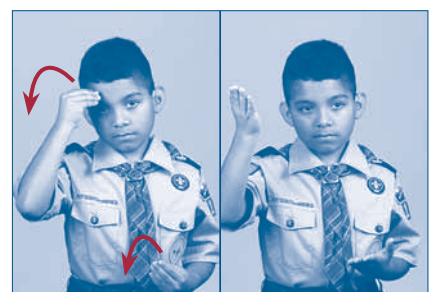

Obey

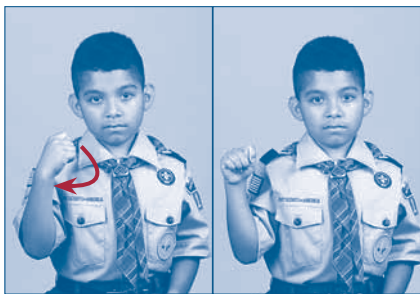

The



Law



Of

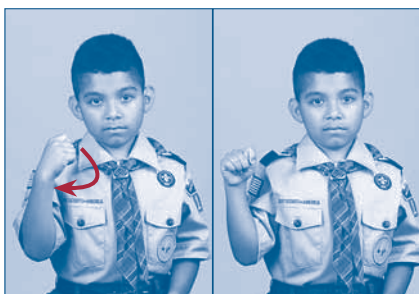

The

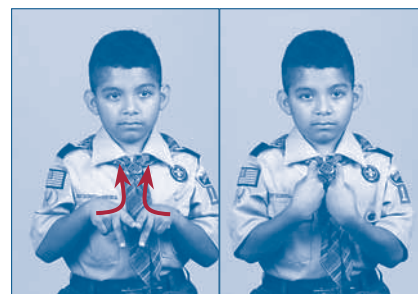

Pack

# CHAPTER 6

## Pack Meeting Closing Ceremonies

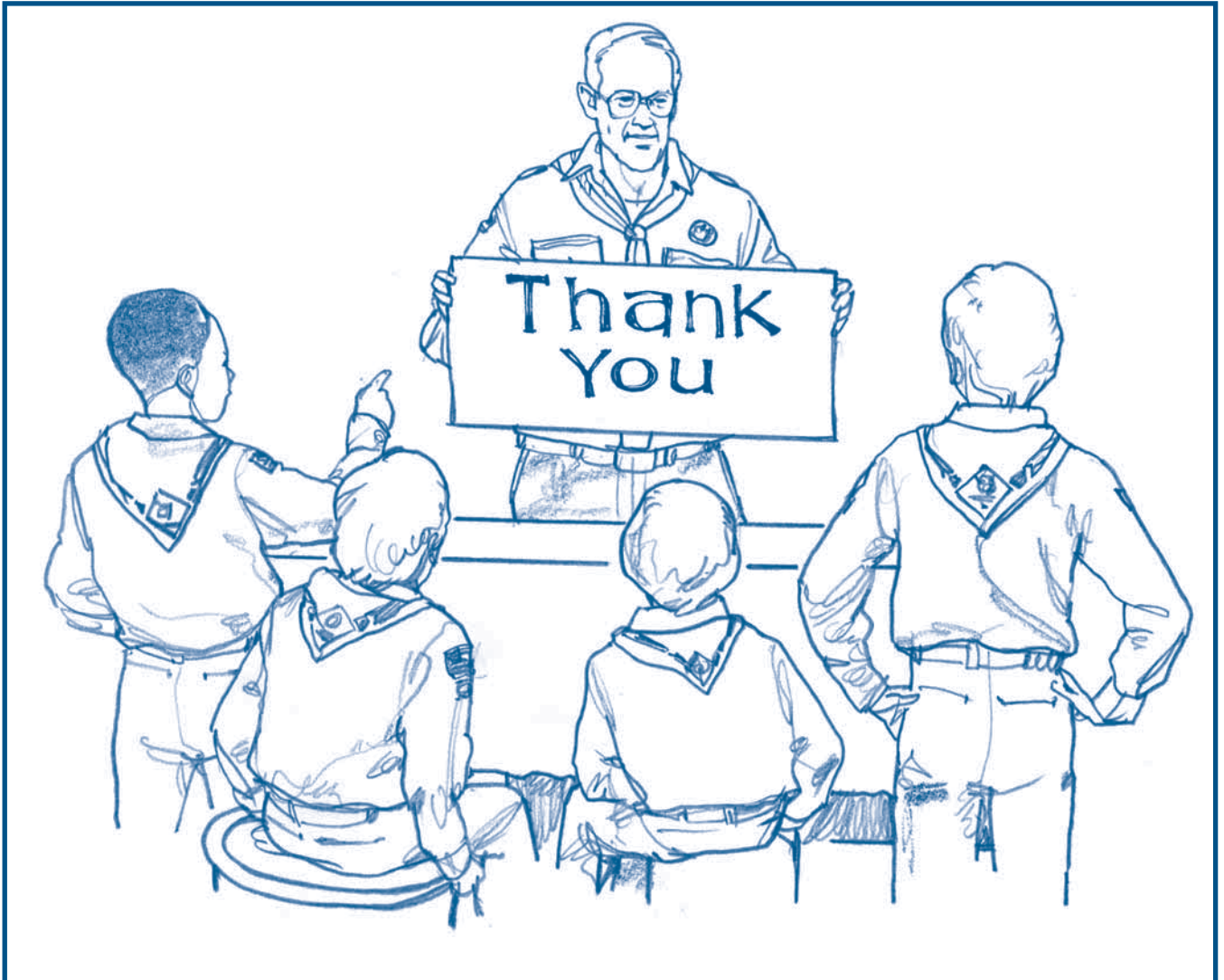

**A Valuable Opportunity, 6-2**

**Ceremonies**

**Short Closing Thoughts, 6-2**

**America's Answer, 6-2**

**Apple Seeds, 6-3**

**Bird Nest, 6-3**

**Bird Watchers, 6-3**

**Blue and Gold, 6-3**

**Compass, 6-3**

**Compass Prayer, 6-3**

**Create or Destroy, 6-4**

**Cub Scout Vespers, 6-4**

**Do Your Best, 6-4**

**Dominoes, 6-4**

**Good News, 6-4**

**Halloween, 6-4**



**I Am Your Flag, 6-4**  
**I Made a Promise, 6-4**  
**I Will Use My Senses, 6-5**  
**Light Switch, 6-5**  
**Making a Difference, 6-5**  
**Nature Visitors, 6-5**  
**One Candle, 6-5**  
**Our Flag, 6-5**  
**Parents, 6-6**  
**Pocketknife, 6-6**  
**Ripple Effect, 6-6**  
**Scout Benediction, 6-6**  
**Scouting History, 6-6**  
**The Sky Is the Limit, 6-6**

**Smile, 6-6**  
**Sportsmanship, 6-6**  
**Stars, 6-6**  
**Stick to It Stamp, 6-7**  
**Sticks, 6-7**  
**“Taps” With Cub Scout Promise, 6-7**  
**“Taps” With Hand Motions, 6-7**  
**Ten Needs of a Boy, 6-7**  
**Thank You, 6-7**  
**Tires Can Take It, 6-7**  
**Trees, 6-8**  
**Value of a Badge, 6-8**  
**World Globe, 6-8**  
**Yardstick, 6-8**

## A Valuable Opportunity

The closing moments of each pack meeting are ideal opportunities to present a brief character lesson. Follow these tips for making your closing thoughts more effective:

- Your meeting should be structured so that the boys are quieter than they were in the beginning and middle of their meeting, and they are in a quiet and reflective mood.
- Use simple props and lighting to enhance your thought.
- Remember that this is a closing thought, not a full-length sermon. Keep it simple!
- Vary the thoughts you use from meeting to meeting. Don't overuse one particular Core Value.
- Vary the length. Use one of the brief sentences or poems and let it stand on its own, without additional comments.
- Invite leaders, adults, or den chiefs to choose and present a closing thought. It will give the boys an opportunity to see other perspectives as well as reinforce the ideas you have been developing.

### Short Closing Thoughts

Keep your eyes and ears open for ideas in everything you read and hear. Remember to give credit to your source when you share someone else's words.

- Remember that it takes both sunshine and rain to make a rainbow.
- The land belongs to many people. Some are alive today, some are dead, but most are yet to be born.

- I am only one person, so I can't change everything in this world. But I am one person, and I can change some things.
- It is far easier to bend a boy than to mend a man. (Baden-Powell)
- Famous people have taken the oath of office for president of the United States and have pledged: "I will, to the best of my ability, preserve, protect, and defend the Constitution of the United States of America." We, as Scouts and families, can also live up to this oath.
- The real way to get happiness is by giving out happiness to other people. (Baden-Powell)
- For every person with a spark of genius, there are a dozen with ignition trouble.
- A boy has two jobs. One is just being a boy. The other is growing up to be a man. (Herbert Hoover)

### America's Answer

**NARRATOR:** America needs citizens who value their heritage. How does a boy come to know and appreciate his heritage as a citizen of the United States of America?

As a Bobcat, he promises to "do my duty to God and my country" and learns to handle and fold the flag. Later, he stands tall as the flag is lowered at camp. He is learning about citizenship. He continues to learn to treasure his American heritage, and he will do all he can to preserve and enrich it. So this young boy comes to manhood. He has grown tall through his Scouting experiences and through the influences of the many men and women who have guided him. He is a Scout. He is America's answer!

## Apple Seeds

**Materials:** An apple and a knife

**NARRATOR:** If I were to give you a choice, which would you rather have, an apple or the apple seeds? (*Cut the apple and take out a few seeds.*)

I guess most of us would choose the apple. A long time ago, there lived a man who would have taken the apple seeds. For many years, Jon Chapman, also known as Johnny Appleseed, walked across hundreds of miles of our country. Everywhere he went, he planted apple seeds. There is a type of seed that you are planting every day, too. It is the seed of fellowship. Every time you help other people, you are planting this seed. Then the seed that you have planted can grow in them, and they can spread it to others, just like the seeds in the apple.

## Bird Nest

**Preparation:** Show a photo or drawing of a bird's nest.

**NARRATOR:** This nest might have been a home for baby birds. Those baby birds are much like the boys who are growing up in our pack.

As these baby birds grow, so does a boy. They will be fed and nurtured by their families. They will watch the example of other birds as they fly through the skies around them.

One day, the birds will leave their nest, just as birds have always done and will continue to do. They will have grown into adults and will play an important role in nature.

A boy will do the same as he grows and flies into adulthood. He will become an important member of his community and his country and will be a leading citizen for everyone to see and admire.

To grow into manhood, a boy must have nourishment for his body and his mind. He must be nurtured by his family and his community along the way, if his ideas and character are to develop.

Our community and our country need this growing youth. Our pack will fly only if we, as families, continue to nourish our youth.

## Bird Watchers

**Preparation:** Have Cub Scouts walk on and read the statement for his rank.

**Personnel:** Bobcat, Tiger Cub, Wolf, Bear, and Webelos Scout, and boy who is working on his Arrow of Light; narrator

**BOBCAT:** I am a Bobcat. Like a sparrow, I work hard to learn about Cub Scouting.

**TIGER CUB:** I am a Tiger Cub. Like a hummingbird, I move quickly from one activity to another.

**WOLF CUB SCOUT:** I am a Wolf Cub Scout. Like a swallow, I swoop and learn many new skills.

**BEAR CUB SCOUT:** I am a Bear Cub Scout. Like a robin, I have colors on my chest to show my accomplishments.

**WEBELOS:** I am a Webelos Scout. I learn much along the Scouting trail that makes me strong and independent like the hawk.

**ARROW OF LIGHT:** I am earning the Arrow of Light, which is the highest award in Cub Scouting. As the eagle is a proud bird, I am also proud of my accomplishments.

**NARRATOR:** Just as we watch the many birds that are around us, we also watch our Scouts grow as they walk the Scouting trail.

## Blue and Gold

**NARRATOR:** Do you know what the blue and gold of Cub Scouting means? Each color has a meaning. Blue stands for truth and spirituality, for steadfast loyalty, and for the sky above. Gold stands for good cheer and happiness, and the warm sunlight. May the meaning behind these two colors shine in your lives as we live the Scouting program.

## Compass

**Preparation:** Hold a compass in your hand as you give this talk.

**NARRATOR:** How many of you have ever held and used a compass? Are you able to find which way is north? In Scouting, we have another type of compass. It's called the Cub Scout Promise. It is an excellent guide for making decisions in life. Whenever you are wondering what to do, say the Cub Scout Promise. It will not always give you an easy answer. Sometimes you'll have to really think it through to make your decision. But chances are, it will help you know the right thing to do.

## Compass Prayer

**CUB SCOUT 1:** From the south, we feel warmth and are secure.

**CUB SCOUT 2:** From the north, the chills of life come and we learn to adapt.

**CUB SCOUT 3:** From the east, we see the rising sun and the promise of a new day of life.

**CUB SCOUT 4:** From the west, we see the setting sun and the peace of night.

**CUB SCOUT 5:** Look up for hope in all the mysteries of life.

**CUB SCOUT 6:** Look down for the security and life the earth gives.

**CUB SCOUT 7:** Look inside yourself to find you in all your splendor.

## Create or Destroy

NARRATOR: One of America's greatest conservationists, Aldo Leopold, said, "The Lord giveth, and the Lord taketh away, but he is no longer the only one to do so. When an ancestor of ours invented the shovel, he became a giver. He could plant a tree. When the ax was invented, he became a taker. He could chop it down."

Each of us possesses the power to create or to destroy. Let us use this power wisely for the good of our country and all humanity.

## Cub Scout Vespers

**Preparation:** Have a den lead "Cub Scout Vespers."

*Tune:* "O Tannenbaum"

As the night comes to this land,  
On my promise I will stand.  
I will help the pack to go,  
As our pack helps me to grow.  
Yes, I will always give goodwill.  
I'll follow my Akela still.  
And before I stop to rest,  
I will do my very best.

## Do Your Best

NARRATOR: When we say the Cub Scout Promise, the words "Do my best" are some of the first words we say. Let's stop for a minute and think about them. What does the word "best" mean? (*Let the boys answer.*) That's right—it means to do something better than we have done it before. You are the only person who knows whether you have done your best. Think about the meaning of this promise and decide that you will always "do your best," no matter what you are doing.

## Dominoes

**Preparation:** Hold up a box of dominoes.

NARRATOR: Does everyone know what these are? Right. This is a box of dominoes.

Imagine that each one of them is a Cub Scout. Have you ever lined them up on a table so that they are standing on their ends? They stand up straight and tall, but as they go through life, there will be winds that try to knock them down.

It doesn't take much to make the dominoes start to fall. And yet, it only takes one domino to stop the entire row from collapsing.

Perhaps the Cub Scout relies on the support of a family member, his den leader, Cubmaster, teacher, or another relative to help him stand tall. Or perhaps he uses what he has learned in Cub Scouting to move out of the influence of drugs or a friend who tells him that shoplifting is OK.

Or perhaps all the dominoes band together for strength in numbers so that they can't be knocked down.

Scouting will help you remain standing tall and proud just like these dominoes.

## Good News

NARRATOR: You all have inside yourselves... a piece of good news. The good news is that you really don't know:

How great you can be,  
How much you can love,  
What you can accomplish, or  
What your potential is.

How can you top good news like that?

—Anne Frank, from her diary

## Halloween

**Preparation:** Make nine large cards with the letters H, A, L, L, O, W, E, E, and N on them.

NARRATOR: H is for Halloween.

CUB SCOUT 1: A is for awesome.

CUB SCOUT 2: L is for laughs.

CUB SCOUT 3: L is for lighted pumpkins.

CUB SCOUT 4: O is for outrageous.

CUB SCOUT 5: W is for wacky.

CUB SCOUT 6: E is for eerie.

CUB SCOUT 7: E is for exciting.

CUB SCOUT 8: N is for nighttime fun!

ALL: HAPPY HALLOWEEN!

## I Am Your Flag

**Preparation:** Display a U.S. flag in a stand. Prepare a card for each Cub Scout with his script on it.

**Materials:** U.S. flag

CUB SCOUT 1: I am the symbol of freedom.

CUB SCOUT 2: I am faith.

CUB SCOUT 3: I am hope.

CUB SCOUT 4: I am love.

CUB SCOUT 5: I am tolerance.

CUB SCOUT 6: I am justice.

CUB SCOUT 7: I am hope for peace on earth.

CUB SCOUT 8: I am a sign for the future.

CUB SCOUT 1: I am the flag of the United States.

## I Made a Promise

CUB SCOUT 1: I made a promise—I said that in whatever I did, I would do the very best I could.

CUB SCOUT 2: I made a promise—to serve my God and my country the best I could.

CUB SCOUT 3: I made a promise—to help other people the best I could.



CUB SCOUT 4: I made a promise—to obey the Law of the Pack the best I could.

CUB SCOUT 5: I have done my best, and I promise to do my best.

CUB SCOUT 6: I am a Cub Scout.

CUB SCOUT 7: Please stand and join us in reciting the Cub Scout Promise.

## I Will Use My Senses

CUB SCOUT 1: This is my country.

CUB SCOUT 2: I will use my eyes to see the beauty of this land.

CUB SCOUT 3: I will use my ears to hear its quietest sounds.

CUB SCOUT 4: I will use my mouth to enjoy the fruits of its harvest.

CUB SCOUT 5: I will use my mind to keep its beauty for future generations.

CUB SCOUT 6: I will use my hands to serve it and care for it.

CUB SCOUT 7: And with my heart, I will honor it.

## Light Switch

**Preparation:** Hold a flashlight or a battery-powered lantern.

NARRATOR: Did you ever stop to think that each one of us is like a light switch? Each one of us gets turned on by different things.

When someone throws your switch, what do they get? Do they get heat, such as anger, arguments, or grumbling? Or do they get light in the form of friendliness, kindness, and understanding?

What you give off depends on what you are plugged into—what you are really like inside as a person. Every day we should try to be a little better than the day before.

When someone throws our switch, we should reflect the very best and brighten up the world around us. (*Turn on lantern or flashlight and shine it on the boys.*)

## Making a Difference

NARRATOR: A young boy walking the beach one morning noticed an old man picking up starfish and tossing them back into the sea. He caught up to the man and asked him why he was doing this. The man explained, “The stranded starfish will die when the sun comes up and they dry out.” Then the boy asked, “But the beach goes on and on, and there are zillions of starfish; how can what you do make a difference?” The man looked at the starfish in his hand and said, “It makes a difference to this one.” And he tossed it safely back into the waves.

## Nature Visitors

CUB SCOUT 1: We enjoy being outdoors but always need to remember those who follow us.

CUB SCOUT 2: Try to be a good visitor and leave the plants and creatures for others to enjoy.

CUB SCOUT 3: The only things I took home with me were drawings, photographs, and memories.

CUB SCOUT 4: I walked on pathways to protect the plants and soil.

CUB SCOUT 5: When I see animals, I remember that I am a guest in their home.

CUB SCOUT 6: I always make sure that all campfires are completely out.

CUB SCOUT 7: When we are careful like this, we’ll be able to leave these things for others to enjoy in the years to come.

## One Candle

**Preparation:** Have one candle or a small light available.

NARRATOR: Let’s turn out the lights. (*Have someone dim the lights.*)

I want you to think about the darkness. (*Pause and then light the candle or turn on the small light.*) Even this one tiny light makes the room seem more cheerful.

That’s the way it can be with a Cub Scout. He might not be very big, but he can light up his home and make the people around him a little happier if he keeps the Scouting spirit alive. Cub Scouts, to do that, always remember to do your best.

## Our Flag

Remember that the Pledge of Allegiance doesn’t always have to happen at the beginning of your pack meeting!

NARRATOR: I have often seen a large flag rippling in the breeze from a flagpole atop a tall building and marveled at its beauty with its 13 red and white stripes and 50 stars on a field of blue. Have you wondered why these colors were chosen? Red is a symbol of bravery, white is a symbol of purity, and blue is a symbol of love and devotion. Our flag is made from cloth that contains millions of threads and stitches, all bound together—each doing its part. In this same way, our country is made up of millions of individuals, with varied religious beliefs and cultural backgrounds, but all are bound together in a common cause to see that liberty and justice exist in our country. Please stand and join me in pledging our allegiance to our flag.

## Parents

CUB SCOUT 1: I would like to ask that families keep these things in mind.

CUB SCOUT 2: Counsel your sons that they may have eyes to behold the red and purple sunsets,

CUB SCOUT 3: and that they may have sharp ears to hear the voice of the Great Spirit.

CUB SCOUT 4: Guide them to have hands that respect the things God has made.

CUB SCOUT 5: Help them be wise and see the lessons hidden in every leaf and rock.

CUB SCOUT 6: Help them seek strength, not to be superior to others, but to help others.

CUB SCOUT 7: Help them to do their best along the Scouting trail.

## Pocketknife

**Preparation:** Hold a pocketknife in your hand.

NARRATOR: I hold in my hand a pocketknife. This is a valuable tool because it can be used for many useful things. It is a dependable tool as long as the blade is kept sharp and free from rust and the working parts are in good condition. But, if it is neglected and becomes dull and rusty, it can be a dangerous tool.

The same thing applies to us. We have a body, and when we keep it in good condition, it will serve us well. If we get plenty of exercise, eat the proper foods, and have healthy habits, we will be able to enjoy the many things we can do. But if we fail to take care of ourselves, we can become rusty and dull like the neglected knife. Do your best to keep fit!

## Ripple Effect

**Preparation:** Hand each person a pebble to drop into the water.

**Materials:** Tub of water and a pebble for each person

NARRATOR: This tub of water symbolizes the world of nature around us. Each pebble that is dropped into the water has an effect on the waves that were caused by the previous pebble. This is the same thing that happens in nature. We are all connected and need to remember that what we do has an impact on everything around us. As you leave, please silently drop your pebble into the water.

## Scout Benediction

NARRATOR: Please stand. *(Pause.)* Now may the Great Master of all Scouts be with us until we meet again.

## Scouting History

NARRATOR: Robert Baden-Powell, a British hero, started Scouting in England. He developed Scouting as an out-

door program for boys with ideals built in. It was a way of thinking, a way of living, a way of doing things.

Today, Scouting is still a program filled with fun and adventure. Men who earned badges as Scouts have served on the Supreme Court, in the United States House of Representatives, and in the United States Senate. The late President John F. Kennedy was the first president who had been a Boy Scout. Former President Gerald Ford was an Eagle Scout. Many of our astronauts were Scouts. More and more men, trained as Scouts, are taking their places in today's world. Please stand with me and repeat the Cub Scout Promise.

## The Sky Is the Limit

NARRATOR: Have you ever heard anyone say the phrase, "The sky is the limit"? This meant that people could make anything of themselves that they wanted. Our astronauts have proved that there is almost no limit to what you can strive to be, either on Earth or in space. How well you perform as a man will depend on how you accept each new challenge as you are growing up. The sky is not the limit. If you want to aim for the stars, you must remember that you are building a launching pad right now in every task you tackle—at home, in school, and in Cub Scouting.

## Smile

**Preparation:** Make and hold up a sign with the word SMILE written on it.

NARRATOR: A smile costs nothing—but creates much. It happens in a flash, but the memory sometimes lasts forever. It cannot be bought, borrowed, or stolen, but it is something that isn't any good until it is given away to someone else. So, if you meet someone who is too weary to smile, give that person one of yours. No one needs a smile quite as much as the person who has none left to give.

## Sportsmanship

NARRATOR: We hear a lot of talk about being a good sport, but just what does that mean? A good sport learns the rules so he can follow them. He competes and does his best. If he wins, he doesn't rub it in but makes positive comments to his competitors. If he loses, he accepts that fact and congratulates the winners. A sportsman accepts defeat, studies how to improve, and determines how to improve his "best."

## Stars

NARRATOR: Baden-Powell, the founder of Scouting, once wrote: "I often think that when the sun goes down, the world is hidden by a big blanket from the light of heaven, but the stars are little holes pierced in that blanket by those who have done good deeds in this world. The stars are not all the same size, but some are big and some small. Some men have done small deeds but

they have made their hole in the blanket by doing good before they went to heaven. Try [to] make your hole in the blanket by doing good while you are on earth. It is something to be good, but it is far better to *do* good.”

Think of Baden-Powell’s message when you promise to help other people.

## Stick to It Stamp

**Preparation:** Hold an envelope that has a postage stamp on it.

NARRATOR: The postage stamp you see on this envelope had the important job of making sure that this piece of mail was delivered to me. The stamp is pretty small, but despite its size, it did the job. Each of you has a job to do in your den and your families. Like the postage stamp, it’s not your size that determines how well you do the job, but how well you stick to it. We aren’t good at all things. Remember the stamp. It did the job despite its size by sticking to the job. Do your best and stick to it until your job is done.

## Sticks

**Preparation:** Have a single stick and then a group of about eight sticks or matchsticks.

NARRATOR: I’m holding in my hand a stick. It’s easy enough to break by itself, isn’t it? (*Demonstrate.*) However, if you take a group of eight sticks, they’re almost impossible to break. (*Demonstrate again.*)

This is true also for us. The single stick is each of you. The group of eight is your den. Can you imagine how strong we are when there is a stick for each adult and boy in our pack?

## “Taps” With Cub Scout Promise

Form the pack in a large circle, with families behind the boys. Have all hum “Taps” quietly while one Cub Scout slowly recites the Cub Scout Promise.

## “Taps” With Hand Motions

**Preparation:** Have one den practice this so they can demonstrate. Have the pack join in the second time.

Day is done. (*Hands out to sides, palms up*)

Gone the sun, (*Turn palms down*)

From the lakes, (*Hands in front at waist height, palms down*)

From the hills, (*Hands in front at shoulder height, palms down*)

From the sky. (*Hands high above head*)

All is well, (*Right hand to left shoulder*)

Safely rest, (*Left hand to right shoulder*)

God is nigh. (*Bow head after singing*)

## Ten Needs of a Boy

CUB SCOUT 1: Every boy has 10 needs:

CUB SCOUT 2: To climb a mountain and look afar,

CUB SCOUT 3: To sit around a campfire with good friends,

CUB SCOUT 4: To test his strength and his skills on his very own,

CUB SCOUT 5: To be alone with his thoughts and his God,

CUB SCOUT 6: To be ready to reach out and find the hand of an understanding adult who is ready and willing to help,

CUB SCOUT 7: To have a code to live by that is easily understood and fair;

CUB SCOUT 8: To have a chance to play hard just for the fun of it and to work hard for the thrill of it,

CUB SCOUT 9: To have a chance to fail...and know why,

CUB SCOUT 10: To have and be a good friend and have a chance to prove both,

CUB SCOUT 11: To have a hero...and a vision to measure him by.

## Thank You

**Preparation:** Hold up a sign with the words THANK YOU written on it.

NARRATOR: The words “thank you” are two simple but very important words. They tell people that you appreciate what they have done. We do good things for others, but do we remember to take the time to thank others who have done something for us? Remember to say, “Thank you.”

## Tires Can Take It

**Preparation:** Hold up a newspaper advertisement for tires.

NARRATOR: Tire manufacturers are always working to make a better tire for our cars—one that can take the pounding and abuse that driving demands. In other words, they are trying to make a tire that can take it.

Like a tire, you and I are put to the test every day. When things are going smoothly, it is easy to smile and take it. The real test is how we do when the going gets rough—when things don’t turn out the way we want them to. At times like these, the Cub Scout Promise can help you carry on with the right attitude and do your share without grumbling. It will help you meet the test. Can you take it?

## Trees

CUB SCOUT 1: Have you ever thought about how helpful a tree is?

CUB SCOUT 2: It provides a nesting place for birds, shade from the sun, and protection from the rain.

CUB SCOUT 3: It discards its dead branches to decay and become soil in the future.

CUB SCOUT 4: It adds beauty to our world.

CUB SCOUT 5: It adds oxygen to our air.

CUB SCOUT 6: A tree gives a lot more than it receives.

CUB SCOUT 7: We can learn a lesson from the tree—by doing our best to always be helpful to others and by putting others first and ourselves last.

CUB SCOUT 8: Remember to give to others more than you receive.

## Value of a Badge

**Preparation:** Hold a Wolf badge in your hand.

NARRATOR: A badge in Scouting is a piece of embroidered cloth. If you were trying to sell that badge, it wouldn't sell for very much money. The real value of the badge is in what it represents: the things you learned to earn it...how to keep healthy, how to be a good citizen, good safety practices, conservation, and many new skills. So when you wear your badge, think of its real value—it represents what you have learned.

## World Globe

**Preparation:** Hold a world globe in your hand and spin it.

NARRATOR: Did you know that all over the world, Scouts just like us are taking part in Scouting activities too? It's true. The Scouting movement exists in more than 100 countries in almost every nation of the world. Their Scouts are very much like us. They have the same ideals and the same brotherhood of service to others. Let's think of all those other Scouts as we say the Cub Scout Promise.

## Yardstick

**Preparation:** Hold a yardstick that has been scored at 10½ inches, 9 inches, and 3 inches.

NARRATOR: This yardstick represents the entire life of your boy. If the average person lives about 72 years, then every half inch on this represents two years. After the age of 21, we really can't influence how people think, or what they do or what they believe. (*Break the yardstick at 10½ inches.*) All we have left is 21 years—this 10½ inches.

Of course, at the age of 18, people are pretty much on their own. They can vote, own property, be married, or defend their country (*Break the scored piece at 9 inches.*) This leaves us 18 years—or this 9 inches—to influence our boys.

But the boys in our pack are at least 6 years old, so this part is already used. (*Break the scored piece at 3 inches.*) We can't get this time back. That leaves us 6 inches or 12 years to make the difference of a lifetime.



# CHAPTER 7

## Induction Ceremonies

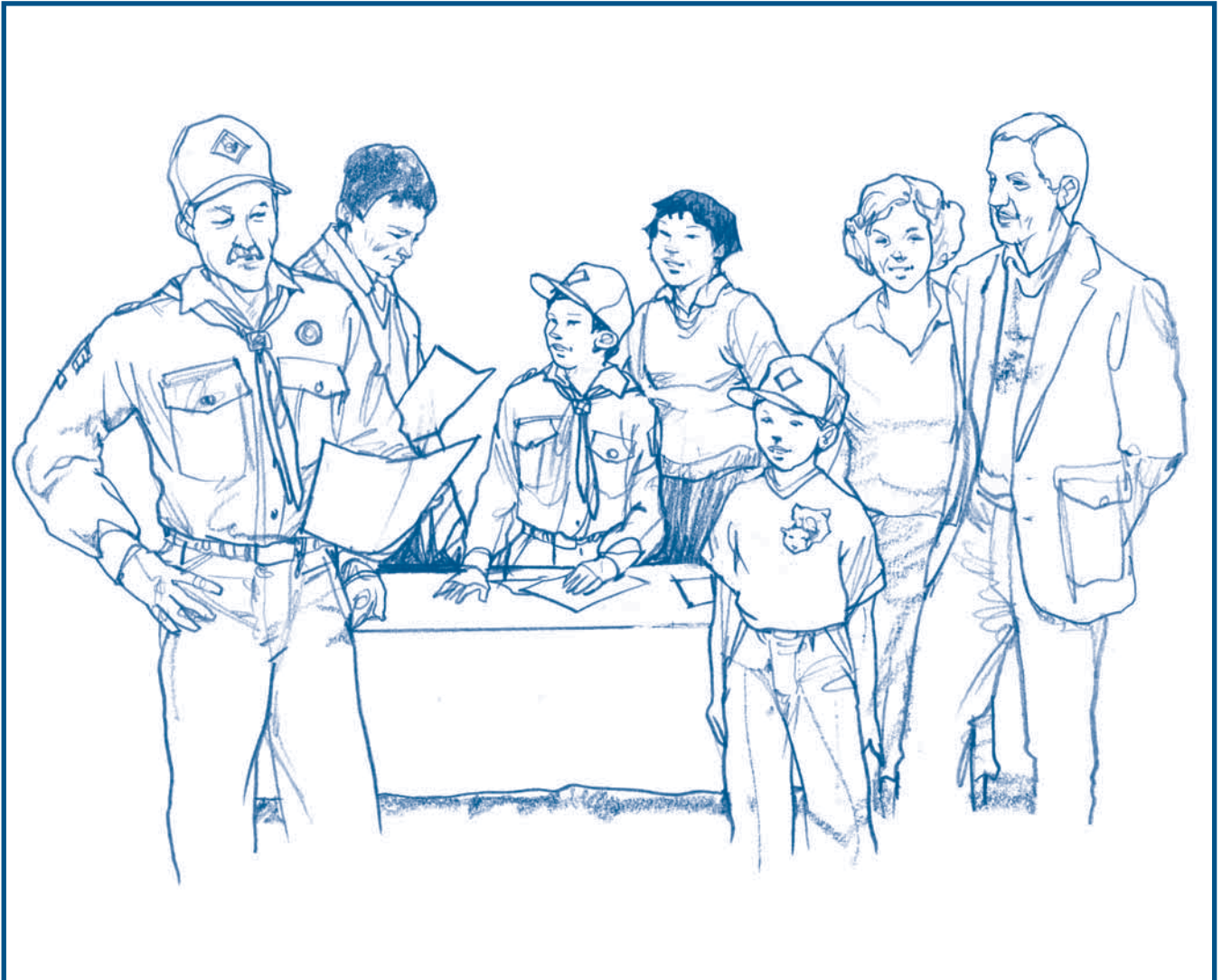

**Why Do We Have Induction Ceremonies? 7-2**  
**Ceremonies**

**Family Induction Into the Pack, 7-2**  
**On the Cub Scout Trail, 7-2**

**Recipe for Cub Scouting, 7-3**  
**This Is Cub Scouting, 7-3**

## Why Do We Have Induction Ceremonies?

Have you ever walked into a group of people you didn't know? Did others come up and immediately introduce themselves? Did it make a difference in how you felt about being there?

All of us have been in new situations like this. A ceremony that inducts families into the pack extends a warm welcome to them. It also lets other people in the pack help them feel welcomed. Another important reason for these ceremonies is that families learn in a special way what is expected of them in Scouting. They learn that this is a family program and there are many things they can do to help their Scout grow. An induction ceremony can make a big difference in how effective they will be and how long they will stay in this program.

### Family Induction Into the Pack (For New Families)

NARRATOR: Families, please make the Cub Scout sign and repeat after me:

I will do my best to support my boy,  
And to guide him to live up to the Cub  
Scout Promise and the Law of the Pack.  
I will work with my boy  
To help him complete his advancements  
to the best of his ability.  
I will sign his book when he has done  
his best.  
I will attend and take part in pack  
meetings with other families.  
I will do my best to make the pack go.

Families, we welcome you into Pack [number]. We are glad to have you with us and wish you well on the Scouting trail.

### On the Cub Scout Trail (For New Cub Scouts and Families)

**Preparation:** Make six posters with an emblem for one of the following on each: Bobcat, Tiger Cub, Wolf, Bear, Webelos, Arrow of Light.

NARRATOR: Tonight, we are welcoming new families into our pack and the Scouting program. Will the following boys and their families please come forward? (*Call the names.*)

We're excited to welcome your families into our pack. You can look forward to fun activities throughout the years as you travel the Scouting Trail.

(*Hand the Bobcat poster to one boy to hold.*) Your first step is to earn the Bobcat badge. This is the first badge you earn, no matter how old you are when you join Cub Scouting.

(*Hand the Tiger Cub poster to another boy.*) If you are in the first grade or are at least 7 years old, you'll work on the five achievements for the Tiger Cub badge. You can also complete projects from the 50 electives.

(*Hand the Wolf poster to another boy.*) If you're in the second grade or are 8 years old, you'll work on 12 achievements for the Wolf badge. You can also complete electives for Gold and Silver Arrow Points.

(*Hand the Bear poster to another boy.*) When you're in third grade or are 9 years old, you'll choose 12 achievements to earn the Bear badge. Just like before, you can complete additional electives to earn Gold and Silver Arrow Points.

(*Hand the Webelos poster to another boy.*) When you're in fourth grade or are 10 years old, you can explore 20 different hobbies and career-related subjects called Webelos activity badges. Then after meeting additional requirements, you'll earn your Webelos badge.

(*Hand the Arrow of Light poster to another boy.*) Tougher challenges follow as you work toward earning the Arrow of Light Award, which is the highest award you can earn in Cub Scouting. It's so special that it is the only Cub Scout rank that you can wear on your Boy Scout uniform. It can even be worn as a knot on your adult leader uniform.

Will the adults please repeat the parent's pledge after me:

I will do my best to support my boy,  
By guiding him to complete the  
achievements to the best of his ability.  
I will sign the appropriate book, when  
he has done his best.  
I will assist his den leader.  
I will attend and take part in pack  
meetings with other families.  
I will do my best to guide him.

We want to welcome you to Pack [number].



## **Recipe for Cub Scouting (For New Boys and Families)**

NARRATOR: Will the following boys and their families please come forward? (*Call the names.*) Some of you may know that when you become Boy Scouts, you'll be cooking outdoors a lot. You'll probably have a chance to do that as a Cub Scout too. To cook a good meal, you usually start with a recipe. If you don't, you'll have to experiment a lot to get it right.

We have a recipe for Cub Scouting, too. Every ingredient is important. If we don't put each ingredient in our Scouting dish, the results would also be questionable. The ingredients are:

CUB SCOUT 1: Boys—the more the merrier.

CUB SCOUT 2: A bucketful of games, sports, and academics.

CUB SCOUT 3: Some crafts where we learn to use tools and make useful things.

CUB SCOUT 4: A bit of seriousness. We learn how to do our duty to God and our country.

CUB SCOUT 5: A cupful of trips and hikes. We explore the world around us.

CUB SCOUT 6: Two barrels of good leaders. We can't have Cub Scouting without these volunteers.

CUB SCOUT 7: And a family for each boy.

NARRATOR: This is the most important ingredient after the first one—the boy. Without the families, a pack can't give you the best of Cub Scouting.

Mix all these ingredients together, and you are sure to have a great time in Cub Scouting. Welcome to Pack [number]. (*Lead an appropriate applause.*)

## **This Is Cub Scouting (For All Adults)**

ADULT 1: Some people think that Cub Scouting is only for boys, but it isn't. Cub Scouting is for the entire family.

ADULT 2: Families work in Cub Scouting with their boys. They begin to see their boys' play and leisure in a new light. The Cub Scouting advancement plan builds a closer relationship among family members.

ADULT 3: Cub Scouts are considerate of others. They promise to help other people and to do their best.

ADULT 4: Cub Scouting is packed with age-appropriate challenges for younger boys, and tackling those challenges leads to the next phase of Scouting—Boy Scouts. When our Cub Scouts join the Webelos den and earn the Arrow of Light Award, they are well-prepared to enter Boy Scouting.

ADULT 5: Cub Scouting works toward strengthening the home. You and your family will strengthen your home by living, playing, and growing together.

ADULT 6: Your boy has only a few more years of boyhood left before he looks away from home for his primary interests. What you do together now is important.

ADULT 7: Will all families please stand and pledge their support to Cub Scouting? Please join with the Cub Scouts in saying the Cub Scout Promise.



# CHAPTER 8

## Advancement Ceremonies

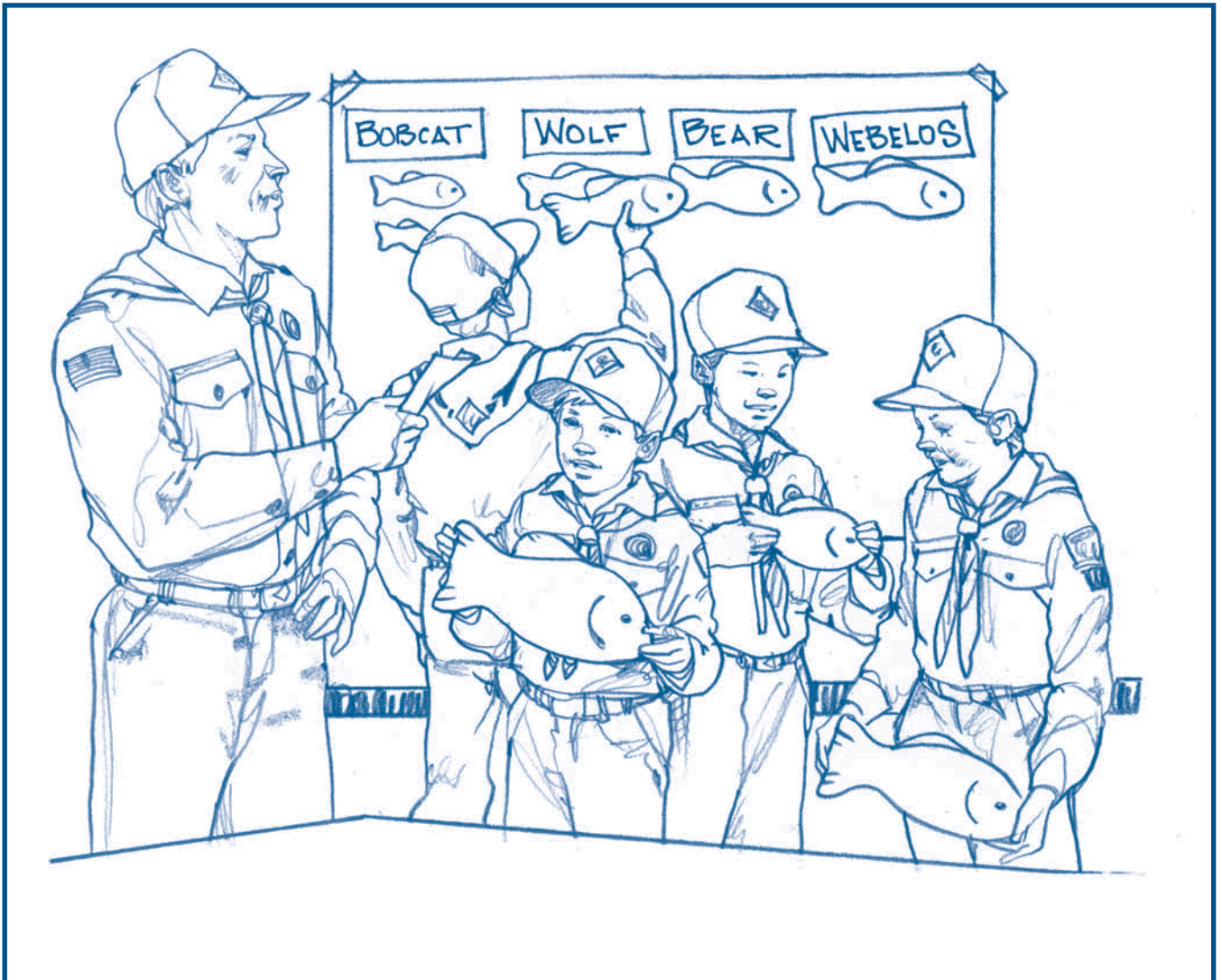

Is It Important to Present Advancement Badges With a Ceremony? 8-2

Adapting Ceremonies, 8-2

Advancement Props, 8-2

Ceremonies

Key to Cub Scouting, 8-2

Tiger Tracks, 8-3

Jungle Book, 8-3

Airplane, 8-3

Baseball, 8-4

Fishing for Advancement, 8-4

Fitness, 8-5

Knights of the Round Table, 8-5

Mountain Climbing, 8-5

Our Flag, 8-6

Pinewood Derby, 8-6

Radio Station C-U-B-S, 8-7

Swimming, 8-7

Wagon Train, 8-8

Painted Paws, 8-8

History of Cub Scouting, 8-9

Inventions and Computers, 8-10

Climbing the Ladder, 8-11

Meaning of the Blue and Gold, 8-11

Six Steps to Boy Scouting, 8-11

Value of a Badge, 8-12

Woodworking, 8-13

Yule Log, 8-13

Top of the Mountain, 8-13

Spirit of Scouting, 8-14

## Is It Important to Present Advancement Badges With a Ceremony?

The answer to this question is, YES! Boys have worked hard to complete the advancement requirements and feel a sense of accomplishment that they have reached their goal. When their efforts are recognized in an impressive ceremony, they are proud and inspired to accomplish even more. Other boys in the pack are also motivated to work harder and complete the achievements toward their next award. If the awards were just handed to the boy with a handshake and congratulations, there could be a sense of disappointment and a question about whether the badge is really such a “big deal.” Don’t let this happen to boys in your pack. Keep the ceremonies effective and fun, and there will always be time to celebrate the accomplishments of boys at each pack meeting.

## Adapting Ceremonies

Depending on the advancements that you have for each month’s pack meeting, you’ll need to adapt these ceremonies to fit your needs.

- You can delete any section that relates to a badge that you are not presenting or change that section to a narrative form in place of the badge presentation. Use your imagination to make the ceremonies work for you.
- A variety of leaders can be involved in the advancement ceremony. You can use an advancement chair, the Cubmaster, assistant Cubmasters, den leaders, den chiefs, and pack trainers.
- Use simple props and costumes to enhance your ceremonies. Tie in the Core Value being focused on for the month. The *Den & Pack Meeting Resource Guide* has ideas for advancement ceremonies that relate to the Core Values. Cub Scout roundtables will also have suggestions and examples.
- Be creative and write your own ceremonies—and then send them to the Boy Scouts of America, Innovation Team, using the form in the appendix.

- Be sensitive to boys who have difficulty reciting in front of a group. All of us have had the experience of forgetting something when we are put on the spot, even if we know it well. Make sure that boys recite the Cub Scout Promise and Law of the Pack in a group. If a single boy is receiving an award, have the pack stand and join him in reciting the Cub Scout Promise.

## Advancement Props

Remember to consider ease of use and storage when designing your props. You’ll find ideas for pack ceremony equipment in the *Cub Scout Leader How-To Book* and *Cub Scout Leader Book*. Use your imagination to develop your own props and equipment.

### Key to Cub Scouting (Bobcat)

**Materials:** An oversized key cut out and painted gold with “Scout Spirit” written on it and smaller keys for each boy receiving the Bobcat badge

**NARRATOR:** We have some boys with us today who recently joined the Scouting program. Will [Names] and their families please come forward?

The Scouting program provides you with many challenges. You attend weekly den meetings and monthly pack meetings. You work on advancement requirements at home with your family and also with your den.

You should set your sights on the Arrow of Light Award early. There is a key to achieving this goal, and it is the key to Scouting. Do you know what it is? (*Wait for responses and point at the key you are holding.*) The key to Scouting is Scout Spirit. Scout Spirit includes teamwork, fair play, and good sportsmanship. It includes that “something special” that makes a Scout want to be the best he can be at everything he does. This key will unlock the door to your achievement.

Remember that with this key to Scouting, you can now begin to walk the Scouting trail. The first step is the Bobcat badge that you are receiving tonight. I will present this badge to your families because of the help they have given you. (*Present badges to families.*)

## **Tiger Tracks (Tiger Cub)**

**Preparation:** Put each Tiger Cub's tiger track beads on a string and attach them to a card that has a tiger paw drawn on it.

CUBMASTER: Several of the Tiger Cubs in our pack have earned tiger tracks. A Tiger Cub earns a tiger track bead for every 10 electives that he completes. There are several choices for electives that help broaden the boys' horizons. Would these Tiger Cubs please come forward? *(Call names and present awards.)* Let's give these Tiger Cubs a big Tiger cheer: "You're great!"

## **Jungle Book (Bobcat, Wolf Cub Scout, Bear Cub Scout)**

NARRATOR: The moon is full, just as it was long ago on that night in the jungle when Mowgli the man-cub first joined the Seonee wolf pack. It has been many years since Mowgli returned from living with the wolves. He has taught us many of the lessons he learned while in the jungle. The most important fact was that the strength of the wolf is the pack. And the strength of the pack is the wolf. That is why we are here tonight in this pack council ring.

### **For Bobcats:**

NARRATOR: Tonight, we have young boys who want to join this pack. Before they join, we must be sure they know the Promise, the Law of the Pack, and the signs that we use. Families, please bring forward the man-cubs who wish to be Bobcats. *(Call their names.)*

You have studied the Cub Scout Promise. Are you ready to make that promise now in front of the pack? *(Bobcat candidates agree.)* Please make the Cub Scout sign with your right hand and say the Cub Scout Promise with me: "I, [Name], promise to do my best, to do my duty to God and my country, to help other people, and to obey the Law of the Pack."

We mentioned the Law of the Pack. This is the law that binds us all together. Will all the Cub Scouts and families who are here tonight, please stand, give the Cub Scout sign, and repeat the Law of the Pack with us: "The Cub Scout follows Akela. The Cub Scout helps the pack go. The pack helps the Cub Scout grow. The Cub Scout gives goodwill."

Pack, please be seated. *(Pause.)* You are now Bobcats in our pack. Families, present this badge to your boys. Pack, look well on your new brothers and know them. Congratulations! Please be seated.

### **For Wolf Cub Scouts:**

NARRATOR: In the jungle, Mowgli was protected by Bagheera, the inky black panther, and was taught the ways of the jungle by Baloo, the great brown bear. We have several boys in our pack who have learned much from Baloo's teaching. We will welcome these boys to the rank of Wolf. Families, please bring forward these man-cubs. *(Call their names.)*

These man-cubs have learned the meaning behind the Cub Scout Promise and the Law of the Pack. They have seen their den mates grow strong as they have helped each other. Families, please present this badge to your boys.

Bear Cub Scouts, do you accept the challenge to continue to study the ways of Baloo? *(Wolf candidates agree.)* Congratulations! Please be seated.

### **For Bear Cub Scouts:**

NARRATOR: Baloo, the sleepy brown bear, continued to teach Mowgli the laws of the jungle. We have some boys in our pack who have passed further tests and are ready to receive the badge of the Bear tonight. Will their families and den leader please bring them forward. *(Call their names.)*

*(To the den leader)* Baloo, you once spoke to Akela in Mowgli's behalf so that he could join the pack. Have these boys learned the Law of the Pack? *(Den leader replies that they have.)* Let's hear them! *(Bear candidates recite the Law of the Pack.)*

Families, you may present this badge to your boys. Congratulations! You may be seated.

Let's give a grand howl on behalf of all the boys who have been recognized for walking farther down the Scouting trail tonight in the jungle.

## **Airplane**

**Materials:** Small pilot wings made from cardboard and covered with foil with the award attached.

NARRATOR: This is your captain speaking. Cub Scout Airlines flight number *(give pack number)* has just taken off for San Francisco, Denver, Chicago, New York, and Atlanta, and is returning to *(your city)*. We will be cruising at 35,000 feet. The weather is clear and calm, and we are expecting a smooth flight.

### **For Bobcats:**

NARRATOR: While we are on board today, we want to recognize our newest passengers, Bobcats *(read names)*. Will these boys and their families please come up to the bulkhead. *(Call their names again and have their families present the badge to their boys.)*

### **For Tiger Cubs:**

NARRATOR: Some of our passengers have been on board for less than a year and have earned the Tiger Cub badge. Will these boys and their adult partners and families please come to the front of the plane? *(Call their names and have their families present the badge to their boys.)*

### **For Wolf Cub Scouts:**

NARRATOR: Some of our passengers have been on board longer and have earned the Wolf award. Will these boys and their families please come up to the front of the plane. *(Call their names and have their families present the badge to their boys.)*



**For Bear Cub Scouts:**

NARRATOR: Several more passengers have earned even more frequent flyer miles. Will new Bear Cub Scouts (*read names*) and their families please come forward. (*Read their names again and have their families present the badge to their boys.*)

**For Webelos Scouts:**

NARRATOR: Some of our most experienced flyers are the boys who have earned their Webelos badges tonight. Will these boys and their families please soar to the front of the plane? (*Call their names and have their families present the badge to their boys.*)

Thank you for joining us on our Cub Scout Airlines flight today. Once again, check to see that your seatbelt is securely fastened and return your tray table and seat to their upright and locked positions as we prepare for landing.

**Baseball**

**Preparation:** Lay out bases around the room. Awards will be presented from each base. Have the pack turn and face the bases as you reach them. Use large symbols of rank on walls or have a leader hold them at each base location. The narrator can wear a baseball hat for a costume.

**For Bobcats:**

NARRATOR: We have some new Bobcats joining our team and would like them to come forward with their families to the on-deck circle. (*Call the names.*) Welcome to Pack [number]! You are just getting started in this Cub Scout game, and we're thrilled that you have learned the rules of the game. Will your families please pin this Bobcat badge on your uniform. (*Present Bobcat badges to families for their boys.*)

**For Tiger Cubs:**

NARRATOR: Several Tiger Cubs are ready to step up to home plate. Will the following boys and their families please come forward. (*Call names.*) You have worked in your den and in your home to complete requirements for the Tiger Cub badge. The support you received at home from your families and adult partner was important to your success. (*Present Tiger Cub badges to families for their boys.*)

**For Wolf Cub Scouts:**

NARRATOR: Several Wolf Cub Scouts have reached first base! Will the following boys and their families please come forward. (*Call the names.*) Your dedication and practice have paid off. Will your first-base coaches please pin this badge on your uniform. (*Present Wolf badges to families for their boys.*)

**For Bear Cub Scouts:**

NARRATOR: Others on our team have reached second base! Will the following boys and their families please report to the second base area. (*Call the names of the boys receiving the Bear badge.*) Congratulations on hitting each of those achievements straight on for your Bear badge! Will your families please pin this award on your team uniform. (*Present Bear badges to families for their boys.*)

**For Webelos Scouts:**

NARRATOR: Reaching third base requires extra effort, and some of our Webelos Scouts have given it all they have. Will the following boys and their families please come forward. (*Call the names of the boys receiving the Webelos badge.*) Each base is more difficult to reach, but you have let nothing stop your slide. Well done! (*Present Webelos badges to families for their boys.*)

Some of our boys are nearing home—the Arrow of Light. As you continue to do your best, I know we'll be seeing you there after you have hit your grand slam!

**Fishing for Advancement**

**Preparation:** Make six sizes of fish—one size for each rank. Put a large sheet of blue paper on the wall behind the area where the awards are presented. This represents an ocean or lake. Have the boys tape their fish in the water after they have received their award.

**For Bobcats:**

NARRATOR: Small fish start out by learning how to maneuver in water, just as our beginning Cub Scouts learn about Cub Scouting. The first step in Cub Scouting is that of a Bobcat. (*Read the names and have the boys and their families come forward. Families present the badge to their boys. The boys then place their fish on the wall.*)

**For Tiger Cubs:**

NARRATOR: Our small fish grows larger. He finds and learns about new food sources just as our Cub Scout learns new skills while earning the Tiger Cub badge. (*Read the names and have the boys and their families come forward. Families present the badge to their boys. The boys then place their fish on the wall.*)

**For Wolf Cub Scouts:**

NARRATOR: Our small fish grows stronger and larger. He finds new food sources and discovers new areas just like our Cub Scout does in earning the rank of Wolf. (*Read the names and have the boys and their families come forward. Families present the badge to their boys. The boys then place their fish on the wall.*)

**For Bear Cub Scouts:**

NARRATOR: Our fish has grown into a larger fish. He has moved into deeper water and is learning to swim faster and travel farther. Just like the fish, our Cub Scout has met more challenges and has earned the rank of Bear. (*Read the names and have the boys and their families come forward. Families present the badge to their boys. The boys then place their fish on the wall.*)

**For Webelos Scouts:**

NARRATOR: Our fish continues to grow. He now has the confidence and perseverance to move into deeper waters, just as our Webelos Scouts have persevered to earn the Webelos badge. (*Read the names and have the boys and their families come forward. Families present the badge to their boys. The boys place their fish on the wall.*)

### **For Arrow of Light Award:**

NARRATOR: Our Webelos Scout, by earning the Arrow of Light Award, has learned much about the school he swims with and is almost ready to move into a bigger school—that of Boy Scouting. (Read the names and have the boys and their families come forward. Families present the badge to their boys. The boys place their fish on the wall.)

We are proud of each of you, as you have learned to swim with the pack.

### **Fitness**

**Materials:** Headbands and wristbands for narrator and leader, sports equipment such as a tennis racket or basketball.

NARRATOR: There are many ways to get into shape. There are personal exercise plans, team sports, and even competition. All must be started slowly, be done on a regular basis, and be challenging for you.

LEADER: The Cub Scout program includes physical fitness as an important part of its program. Each rank has age-appropriate requirements for the boys eligible to earn it.

NARRATOR: Good physical shape also requires good mental shape. Stepping into shape is like stepping up the Scouting trail. They both make you look and feel better and can be fun. Today, we're going to honor some boys who have begun taking those steps to get into shape on the Cub Scout trail.

LEADER: Will the following Cub Scouts and their family coaches please step right up. *(Call the names of the Bobcats.)*

NARRATOR: The Bobcat is a person just beginning to get into shape. He is learning the routine and practicing the steps. Families, please present these awards to your boys. *(Present Bobcat badges to families to give to their boys.)*

LEADER: Another group of boys has been working hard to get into shape and is ready to advance along the Cub Scouting trail. Will the following Cub Scouts and their families come forward. *(Call the names of Tiger Cubs.)*

NARRATOR: The Tiger Cub has been practicing his skills with his den and his family. He is ready to earn the second rank on the Cub Scouting trail. Families, please present these Tiger Cub badges to your boys. *(Present Tiger Cub badges to families to present to their boys.)*

LEADER: Several boys have taken the next step to improve their physical fitness, and they are ready to advance along the Scouting trail. Will the following Cub Scouts and their families please step up. *(Call the names of the Wolf Cub Scouts.)*

NARRATOR: These boys are advancing in their fitness every day. They are following the program set up by their coaches and have earned the third rank in Cub Scouting, the Wolf. Families, please give these badges to your boys. *(Present Wolf badges to families to give to their boys.)*

LEADER: Our Bear candidates have accepted new challenges and continue to develop their physical and mental skills. Will the following Cub Scouts and their families please come forward. *(Call the names of the Bear Cub Scouts.)*

NARRATOR: To reach this step, it takes a dedication to reaching the goal. Families, please give the Bear badge to your boy. *(Present Bear badges to families to give to their boys.)*

LEADER: Webelos Scouts have been competing in a series of tests called activity badges. Will the following Webelos Scouts and their families please come forward. *(Call the names of the Webelos Scouts.)*

NARRATOR: The tests of the activity badges have given you new challenges to improve your mental and physical skills. You have given your best! Will your families please attach your Webelos badge. *(Present Webelos badges to families to give to their boys.)*

Congratulations to all of you who have given your personal best to reach these goals!

### **Knights of the Round Table**

NARRATOR: In our Cub Scouting kingdom, several of our knights have performed tasks so well that they are worthy of special recognition.

Will the following boys and their families please come forward. *(Call the names of the new Bobcats.)* These Cub Scouts are worthy of the order of the Bobcat. In the name of Akela, your families will present you with your badge of knighthood.

Will the following boys and their families please come forward. *(Call the names of those receiving Tiger Cub badges.)* These Cub Scouts are worthy of the order of the Tiger Cub. In the name of Akela, your families will present you with your badge of knighthood.

Will the following boys and their families please come forward. *(Call the names of those receiving Wolf badges.)* These Cub Scouts are worthy of the order of the Wolf. In the name of Akela, your families will present you with your badge of knighthood.

Will the following boys and their families please come forward. *(Call the names of those receiving Bear badges.)* These Cub Scouts are worthy of the order of the Bear. In the name of Akela, your families will present you with your badge of knighthood.

Will the following boys and their families please come forward. *(Call the names of those receiving Webelos badges.)* These Cub Scouts are worthy of the order of the Webelos. In the name of Akela, your families will present you with your badge of knighthood.

May you all carry with you the true spirit of the Cub Scouting kingdom.

## Mountain Climbing

NARRATOR: Just as mountain climbers love to challenge mountains, Cub Scouts challenge the mountain of Scouting.

### For Bobcats:

NARRATOR: Bobcats, you stand at the foot of the mountain. You are just embarking on your journey. You have many exciting adventures ahead of you on the Cub Scout trail. Will the following new Bobcats please come forward with their families. *(Call the names and present the badges to families to give to their boys.)*

### For Tiger Cubs:

NARRATOR: As Tiger Cubs, you have reached the first plateau of Scouting. You might feel that you haven't gone far yet, but you have accomplished many things. Doing your best at each task is what it takes to reach the top of the mountain of Scouting. Will the following new Tiger Cubs please come forward with their families. *(Call the names and present the badges to families to give to their boys.)*

### For Wolf Cub Scouts:

NARRATOR: Wolf Cub Scouts, you are almost halfway up the mountain. Some of you might have slipped on the ropes on the way up, but you have all found secure ground in receiving your badge today. Will the following new Wolf Cub Scouts please come forward with their families. *(Call the names and present the badges to families to give to their boys.)*

### For Bear Cub Scouts:

NARRATOR: Bear Cub Scouts, you have now come far enough up the mountain to feel that the air is thinner and there are fewer and fewer trees. You still have more ridges to climb, and your fellow climbers and leaders will be there to help and guide you. Will the following new Bear Cub Scouts please come forward with their families. *(Call the names and present the badges to families to give to their boys.)*

### For Webelos Scouts:

NARRATOR: Webelos, you are now hiking above the tree line, and the sense of accomplishment you feel has made the trip worthwhile. The summit of the mountain looms before you and the skills you have gained have prepared you for what lies ahead. Will the following Webelos Scouts please come forward with their families to receive their Webelos badge. *(Call the names and present the badges to families to give to their boys.)*

Scouts, looking up, you see the summit of the mountain of Cub Scouting—the Arrow of Light Award. The higher you climb, the more determined you are to reach the peak.

## Our Flag

**Preparation:** Move the U.S. flag next to the advancement ceremony area.

NARRATOR: Our country's flag is made up of several parts, like the Cub Scout program.

Our flag contains the color white. White is a clean, new color. New Cub Scouts, who become Bobcats and Tiger Cubs, bring fresh and clean enthusiasm into our pack. To represent the white in our pack, I would like to ask the new Cub Scouts and their families to come forward. *(Call the names and ask the families to give the badges to the boys.)*

Red is also found in our flag. Red is a lively, active color. Representing the red are the new Wolf Cub Scouts of our pack. Will the following boys and their families please come forward. *(Call the names and ask the families to give the badges to the boys.)*

Our flag also has a field of blue. Blue is an older and wiser color. These are the same qualities that are seen in the Bear Cub Scouts of our pack. Will the following boys and their families please come forward. *(Call the names and ask the families to give the badges to the boys.)*

It is important to have something to fly the flag from, too. A flagpole will provide a strong support and base for our country's colors. Boys who are working on their Webelos badge provide strong support for our pack. Will the following boys and their families please come forward. *(Call the names and ask the families to give the badges to the boys.)*

Of course, you can't forget the stars on our flag. Cub Scouts who reach the Arrow of Light Award are stars in every sense of the word. This award can be worn on their Boy Scout uniform and as a knot on their adult Scouting uniform. Let's all reach for the star in Scouting.

## Pinewood Derby

*(This ceremony can also be easily adapted for the space derby or raingutter regatta.)*

**Preparation:** Have small posters with the emblem of each rank on them. Attach the posters to the side of the pinewood derby track starting with the Bobcat at the bottom and the Arrow of Light at the top.

NARRATOR: We had a wonderful time today watching the pinewood derby cars race down this track. They really speed downhill, don't they? Did you know you could go uphill on this same track? It's a little harder, but it's worthwhile to make the trek from Bobcat, to Tiger Cub, to Wolf, to Bear, to Webelos, and finally to Arrow of Light. Pack [number] has been climbing this course, and now we're going to report on the new positions that our cars have taken in the lineup.

Will the following Cub Scouts who have made the climb as far as Bobcat this past month, please come forward with their families? *(Call the names and ask the families to give the badges to the boys.)*

Will the following Cub Scouts who have made the climb as far as Tiger Cub this past month, please come forward with their families? *(Call the names and ask the families to give the badges to their boys.)*



Will the following Cub Scouts who have made the climb as far as Wolf this past month, please come forward with their families? *(Call the names and ask the families to give the badges to the boys.)*

Will the following Cub Scouts who have made the climb as far as Bear this past month, please come forward with their families? *(Call the names and ask the families to give the badges to the boys.)*

Will the following Cub Scouts who have made the climb as far as Webelos this past month, please come forward with their families? *(Call the names and ask the families to give the badges to the boys.)*

Will the following Cub Scouts please come forward with their families. *(Call the names and ask them to come forward with their families.)* Congratulations. You have reached the top of the track. The checkered flag has been waved and you have achieved the Arrow of Light Award. *(Have families present the badges to the boys.)*

Congratulations on your current standings! Keep the checkered flag in your sights!

## **Radio Station C-U-B-S**

**Materials:** Two hand-held microphones (real or made from paper towel tubes).

NARRATOR: This is radio station C-U-B-S reporting live today from the meeting of Pack [number]. Tonight, several of our new listeners have earned awards. Let's welcome them now!

Will the following Bobcat candidates and their families join us on stage. *(Call the names.)* Cub Scouts, will you please show that you are ready to receive your Bobcat badges by joining me in the Cub Scout Promise?—"I, [Name], promise to do my best, to do my duty to God and my country, to help other people, and to obey the Law of the Pack."

It's my pleasure to present your Bobcat badges to your families to pin on your shirts.

LEADER: This is the radio station C-U-B-S mobile unit out on the Cub Scout trail. We've spotted several Cub Scouts who have reached the Tiger Cub level. I'll send the following Scouts and their families to your location. *(Call the names.)*

NARRATOR: We're glad that you have completed the 12 achievements to reach the rank of Wolf. Your families will have the honor of presenting your new badges.

LEADER: Believe it or not, some new Bears have been spotted in the vicinity! Will the following Bear Cub Scout candidates and their families please come forward. *(Call the names.)*

NARRATOR: Congratulations on doing your best to complete the requirements needed for the rank of Bear! Will your families please present this award.

LEADER: I'm about to return to the radio station, but I've located one more group we've been searching for. The following Webelos Scouts have earned the Webelos badge! *(Call the names.)*

NARRATOR: These Webelos Scouts have been completing Webelos activity badges and other requirements to receive this once-in-a-lifetime badge. Will your families please present this award.

This is radio station C-U-B-S signing off the air but inviting you to stay tuned to great Cub Scouting. We'll meet you right back here at station [pack's number] next month!

## **Swimming**

NARRATOR: Water safety is an important subject for us.

### **For Bobcats:**

NARRATOR: Before you can learn to swim, you have to be willing to venture out into the water. We have some boys who have just begun to test the waters of Cub Scouting and have earned their Bobcat badge. Will the following boys and their families please come forward. *(Call the names and ask the families to present the badges to the boys.)*

### **For Tiger Cubs:**

NARRATOR: As beginning swimmers, we learn to put our faces in the water. We work on getting used to the water so we can be comfortable and safe in it. We have some beginning Cub Scouts who are getting used to the Cub Scout program and have earned their Tiger Cub badge. Will the following boys and their families please come forward. *(Call the names and ask the families to give the badges to the boys.)*

### **For Wolf Cub Scouts:**

NARRATOR: The next thing we learn in swimming is how to float. We have several Cub Scouts who have earned the Wolf badge and are able to float on their own in the Cub Scout program. Will the following boys and their families please come forward. *(Call the names and ask the families to give the badges to the boys.)*

### **For Bear Cub Scouts:**

NARRATOR: Our next step is to learn to kick and propel ourselves through the water. We have several boys who have earned the rank of Bear and have mastered the kick that propels them through the Cub Scout program. Will the following boys and their families please come forward. *(Call the names and ask the families to give the badges to the boys.)*

### **For Webelos Scouts:**

NARRATOR: After learning how to kick, we have to learn strokes with our arms. Learning to coordinate kicking, breathing, and arm strokes is a challenge. Today, we have some boys who have been able to coordinate their requirements and activity badges to earn the rank of Webelos. Will the following boys and their families please come forward. *(Call the names and ask the families to give the badges to the boys.)*

Learning to swim and the world of Scouting open up a whole new world for our boys and families.

## Wagon Train

NARRATOR: To the wagon trains heading west, the trip was definitely a challenge. The days were long, the road was rough, and the food was sometimes barely edible. The pioneers traveled in groups so they could help each other, working as a team, with each person having responsibilities according to his or her skills.

Walking alongside the wagon train are the Bobcats and Tiger Cubs. *(Call the names and have the boys and their families come forward. Families give the badge to their boys.)*

Our new Wolf Cub Scouts are in charge of the horses and oxen that pull the wagons. They are the future strength of our wagon train. *(Call the names and have the boys and their families come forward. Families give the badge to their boys.)*

Honing their skills, our new Bear Cub Scouts have proved their ability to meet the demands of the trail and to seek out new adventures. *(Call the names and have the boys and their families come forward. Families give the badge to their boys.)*

Webelos are the Scouts for our group. Their knowledge and experience set the goals of achievement for the pack and give continuity to our crew. *(Call the names and have the boys and their families come forward. Families give the badge to their boys.)*

Ladies and gentlemen, it's time to hit the trail again! The trail can be long and tiring, but as long as we work together, we'll reach our destination. I'm proud to travel with this group. Westward, ho!

## Painted Paws (Wolf, Bear, Webelos Scout, Arrow of Light)

**Materials:** Marking pens in colors: black for Wolf Cub Scouts; brown for Bear Cub Scouts; blue, gold, green, and red for Webelos; blue and gold for Arrow of Light; and pieces of vinyl or cardstock to draw the paws for "painting." Bolo ties, badges, or necklaces could be made.

NARRATOR: When a boy joins our Cub Scout pack, he earns the Bobcat badge and starts on the Scouting trail. This trail will lead him through Bobcat, Tiger Cub, Wolf, Bear, Webelos, and finally to the highest award of Cub Scouting, the Arrow of Light. Tonight we are honoring boys who have earned advancement during their journey.

### For Wolf Cub Scouts:

NARRATOR: Will the following boys and their families please come forward. *(Call the names of Wolf badge recipients.)* Do you seek the rank of Wolf? *(They reply, "Yes.")* Please recite with me the Cub Scout Promise: "I, [Name], promise to do my best, to do my duty to God and my country, to help other people, and to obey the Law of the Pack."

I can see by your knowledge of the Cub Scout Promise and the achievements you have completed that you have worked hard along with your families. These achievements are important because they have helped you gain a deeper appreciation of many things. You are now ready to wear the mark of the wolf paw. *(The den leader draws the following marks on the boys' vinyl badges with a black marking pen.)*

The first toe of the wolf is for your growth through feats of skills and having fun with your families. *(Draw the first toe in black.)*

The second toe of the wolf paw represents what you have learned about your home, community, and country as well as learning more about your religious beliefs. *(Draw the second toe in black.)*

The third toe of the wolf paw stands for the skills you have gained in handling tools, tying things, and making collections. *(Draw the third toe in black.)*

The fourth toe of the wolf paw represents your new appreciation for conservation as well as safety in home and traffic. *(Draw the fourth toe in black.)*

The pad of the wolf paw represents your growth as a Cub and the increased responsibility you are now capable of carrying. *(Draw the pad in black.)*

Wolf cubs, remember the inscription of this paw. It shows you are ready to move along the Scouting trail. Families, please give these badges to your boys.

### For Bear Cub Scouts:

NARRATOR: Today, we have some Cub Scouts who have worked hard to achieve the rank of Bear. Will the following boys and their families please come forward. *(Call the names of the Bear badge recipients.)*

You are climbing the trail to reach the honor of Arrow of Light in Cub Scouting and the rank of Eagle in Boy Scouting. To help you on your journey, we will inscribe you with the paw of the bear. *(The den leader draws the following marks on the boys' vinyl badges with a brown marking pen.)*

The first toe of the bear paw symbolizes your increased understanding of God. *(Draw the brown circle of the first toe.)*

The second toe of the bear paw symbolizes your knowledge of your country, its folklore and heritage. *(Draw the brown circle of the second toe.)*

The third toe of the bear paw, shows your increased appreciation of your family and its value. *(Draw the brown circle of the third toe.)*

The fourth toe of the bear paw stands for your increased understanding of your self-worth. *(Draw the brown circle of the fourth toe.)*

The fifth toe of the bear paw represents your knowledge of the Law of the Pack. *(Draw the brown circle of the fifth toe.)*



The palm of the bear paw represents your growth as a Cub Scout, and the increased responsibility you carry. *(Draw the brown palm of the paw.)*

The climb is getting shorter but steeper...not everyone will finish. Follow the guidelines of the Law of the Pack so that you will be safe along the trail. Congratulations to you and your families for your hard work. *(Present the badges to families to give to their boys.)*

#### **For Webelos Scouts:**

NARRATOR: Webelos stands for “WE’ll BE LOyal Scouts.” Will the following Webelos Scouts and their families please come forward. *(Call the names of the Webelos badge recipients.)*

The Webelos badge signifies a major step on the path of Cub Scouting on your way to Arrow of Light Award and into Boy Scouting. We will be painting you with the colors of the Webelos Scout neckerchief. *(The Webelos den leader draws the following marks on the boys’ vinyl badges with blue, gold, green, and red marking pens.)*

The first blue dot represents the three activity badges you have earned as an active member of your Webelos den. *(Draw a blue dot on the back of the band.)*

The second blue dot stands for your understanding of the Webelos badge and uniform. *(Draw a second blue dot.)*

The third dot shows that you understand and intend to live by the Scout Oath, the Scout Law, the Scout motto, and the Scout slogan. *(Draw a third blue dot.)*

The fourth blue dot shows that you know the Scout salute, the Scout sign, and the Scout handshake and that you know when to use them. *(Draw a fourth blue dot below the top three.)*

The fifth blue dot represents your agreement to follow the Outdoor Code. *(Draw a fifth blue dot below the top three.)*

Two V’s will now connect these dots. The first V stands for the flag ceremony you have led. *(Connect the two dots on top with one lower blue dot to make one side of the W.)* The second V represents the practice of your religious faith. *(Draw a second V connecting the two dots on top with the other lower dot, completing the W.)* The letter that has been formed is a “W,” symbolic of the total effort you have made to attain your Webelos badge.

The Webelos colors are gold, green, and red. These colors represent the Scouting program. Gold represents the Cub Scout program. Gold is the color of the sun and will light your way along the Scouting trail. *(Draw a gold line under the W.)*

Red represents the Boy Scout program. Red stands for your heart so that you will have a burning desire to scout new areas. *(Draw a red line under the gold one.)*

Green represents the Venturing program. Green stands for the tree so that you will stand tall as you venture onward. *(Draw a green line under the red one.)*

Wear your Webelos badge proudly as you continue to work toward your Arrow of Light Award. *(Present the badges to families to give to their boys.)*

#### **For Arrow of Light Recipients:**

NARRATOR: Today, we have some Webelos Scouts who have earned Cub Scouting’s highest award. Will the following Scouts and their families, please come forward? *(Call the names of Arrow of Light recipients.)*

Our pack honors you for the work you have done. You have earned your Webelos badge and have been active in your Webelos den. You can now repeat from memory the Scout Oath and the 12 points of the Scout Law. You practice them in your everyday life. You know the Scout motto, slogan, sign, salute, and handshake and what they stand for. You understand the different parts of the Scout badge and know what they represent. You know the parts of the Boy Scout uniform and have visited a Boy Scout troop. You have attended a Boy Scout-oriented outdoor activity. You have participated in a Webelos den overnight campout or day hike and have shown an interest in becoming a Boy Scout. In earning the Arrow of Light Award, you have shown that you have done your best. To show this, we will mark your special badge with the Arrow of Light. *(A Webelos den leader makes markings on the back of the boys’ vinyl badges.)*

The color blue stands for the spirit of Cub Scouting, and this arrow shows the way of the Scouting trail. *(Draw a long arrow in blue.)*

The color gold stands for the rays of the sun and is used to show the seven virtues of life. *(Draw a curved yellow line for the sun.)* The first ray represents wisdom. *(Draw the first yellow ray.)* The second ray stands for courage. *(Draw the second yellow ray.)* The third ray shows your self-control. *(Draw the third yellow ray.)* The fourth ray is for justice. *(Draw the fourth yellow ray.)* The fifth ray is for faith. *(Draw the fifth yellow ray.)* The sixth ray is for hope. *(Draw the sixth yellow ray.)* The seventh ray is for love. *(Draw the seventh yellow ray.)*

These seven virtues will help you lead a happy and successful life. Will your families please present your Arrow of Light Award. *(Present the badges to families.)* Congratulations!

## **History of Cub Scouting**

NARRATOR: We all have heard that William Boyce started the Boy Scouts of America after he was helped in a London fog by a boy who refused a tip because he was a Scout. Mr. Boyce was so impressed by this boy and his talk with Lord Baden-Powell that he helped start the Boys Scouts of America, which was incorporated on February 8, 1910.

Almost as soon as Scouting began, younger boys started clamoring for a chance to participate in Scouting. This resulted in the Wolf Cub program being started in England in 1916. As we read in the *Wolf HandBook*, the

basis for much of this program came from *The Jungle Book* by Rudyard Kipling, who was a friend of Baden-Powell's. This book is the story of two wolves that find a man-cub who is being hunted by Shere Khan, the tiger. They take in the boy and raise him as part of their family. He is named Mowgli, which means frog.

The wolves are part of a pack that is led by Akela, the great gray wolf. New cubs must be presented to the wolf pack for acceptance. If they are not accepted by two members of the pack, they are turned away. When Mowgli was presented to the council, none of the other wolves would speak for him. Baloo, the kindly brown bear who taught the wolves the law of the jungle, stood up and said, "I will speak for the man-cub." When no one else spoke, Bagheera, the black panther, rose and offered to pay the price of one bull if the man-cub would be accepted into the pack. And so it was that Mowgli became a part of the Seonee wolf pack, for the price of a bull and on Baloo's good word.

#### **For Bobcats:**

NARRATOR: In looking back at old Cub Scout books, we are reminded that the Cub Scout program has survived with very little change. In a 1930 Cub Scout book, the rules for becoming a Bobcat were: "He has taken the Cub Scout Promise, explained and repeated the Law of the Pack, explained the meaning of the ranks, shown the Cub sign and handclasp, given the Cub motto and salute."

Today, as Bobcats, we do most of the same requirements. When Akela says that we are ready, we are presented to the pack for acceptance and recognition.

Will the following Cub Scouts and their families please come forward. (*Call the names of the Bobcats and present the badges to families to give to their boys.*) Just as the wolf cubs learned about the world around them by taking short trips into the woods, so have our own Bobcats grown in their understanding of nature and their families.

#### **For Tiger Cubs:**

When Tiger Cubs began in 1982, boys worked on Big Ideas rather than badges. Their uniform was a T-shirt, and they earned iron-on Tiger Paws to be placed on that shirt. Today, Tiger Cubs work on achievement in their dens and with their family to earn a badge just like the Cub Scout ranks.

Will the following Tiger Cubs and their families please come forward. (*Call the names of Tiger Cub badge recipients and present the badges to families to give to their boys.*)

#### **For Wolf Cub Scouts and Arrow Points:**

NARRATOR: Will the following Cub Scouts and their families please come forward. (*Call the names of the Wolf recipients and present the badges to families to give to their boys.*) Originally, only two Arrow Points could be earned for each rank. The first 10 electives earned the Gold Honor Arrow Point, and the next 10 earned the silver rank. Today, we award the Gold Arrow

Point for the first 10 electives completed and Silver Arrow Points for each 10 additional electives that Wolf and Bear Cub Scouts complete. Will the following boys please come forward. (*Call the names and present the Arrow Points.*)

#### **For Bear Cub Scouts:**

NARRATOR: Baloo, the kindly brown bear, taught the young wolves the secret names of the trees, the calls of the birds, and the language of the air. Each of you has learned to help others in your den meet the requirements for the Bear badge. Will the following Cub Scouts and their families please come forward. (*Call the names of the Bear badge recipients and present the badges to families to give to their boys.*)

#### **For Webelos Scouts:**

NARRATOR: Until 1967, the next rank was Lion. It was then changed to Webelos, and the program was expanded. Webelos was a word used since 1930 to mean, "WE'LL BE LOyal Scouts." The Webelos colors and 15 activity badges were added. A new Webelos badge was introduced—the emblem we know today as the Arrow of Light. In 1978, the Webelos badge was reinvented and a new rank was introduced, the Arrow of Light.

The Webelos program is a transition from Cub Scouts to Boy Scouts. To achieve the Webelos badge, Webelos Scouts earn activity badges, learn many of the Boy Scout rank requirements, and are encouraged to get involved in religious and community activities.

Will the following Webelos Scouts and their families please come forward. (*Call the names of the Webelos recipients and present the badges to families to give to their boys.*)

#### **For Arrow of Light Recipients:**

The Arrow of Light Award is the highest award in Cub Scouting. It can also be worn on the Boy Scout uniform in recognition of your achievement. Will the following Webelos Scouts and their families please come forward. (*Call the names of the Arrow of Light recipients and present the badges to families to give to their boys.*)

You won't want to stop here because the trail leads on to Boy Scouting and great new adventures.

## **Inventions and Computers**

**Preparation:** Decorate a box so that it looks like a computer and monitor and place it on a table. Include slots for inserting large cards you make to represent each Cub Scout rank that you will award and hidden flaps that open. Store badges and awards behind these flaps. Cover the computer with a sheet.

NARRATOR: We've been talking about inventions today, and I'd like to share my newest invention. (*Unveil the computer.*) This amazing device is able to collect all the information that comes in from our pack committee members, den leaders, and families. It can then deter-

mine which Cub Scouts have earned awards. Allow me to demonstrate. *(Hold up a Bobcat card and insert it into slot in machine. Then remove Bobcat badges from a hidden flap that opens.)*

Will the following Cub Scouts and their families please come forward. *(Call the names and present the badges to families to give to their boys. Follow the same procedure for each rank or award.)* These young men have worked long and hard to achieve these goals. What they have built is not a better mousetrap, but something far more valuable to the world today—better young men. Congratulations to all of you for doing your best.

## **Climbing the Ladder**

**Materials:** Ladder advancement board and clothespins shown on page 3-4.

NARRATOR: Several of our Cub Scouts have climbed the advancement ladder and have grown in knowledge this month. Will the following boys and their families please come forward. *(Call the names.)* What are some of the achievements you completed to earn this rank? *(Talk to the boys and families ahead of time so that they will be prepared. Give them each 30 seconds.)*

Will you please move your name to the next level on the advancement ladder. *(Allow time for this.)* Your families are an important part in your advancement, and it is their honor to present this badge to you. *(Present the badges to families to give to their boys.)* Congratulations!

## **Meaning of the Blue and Gold (All Ranks and Arrow Points and Webelos Activity Badges)**

NARRATOR: Blue and gold represent some of what Cub Scouts learn as they walk the Cub Scout trail.

Gold stands for good cheer. The boys who have learned the basics of Cub Scouting and have earned their Bobcat badge and Tiger Cub badge are full of the good cheer of Cub Scouting. Will the following Cub Scouts and their families please come forward. *(Call the names and present the badges to families to give to their boys.)*

Gold stands for happiness, and no one seems to be more full of happiness than those who have completed the 12 achievements for the rank of Wolf. Will the following boys and their families please come forward. *(Call the names and present the badges to families to give to their boys.)* After earning this rank, several boys have gone on to complete additional electives to earn Gold and Silver Arrow Points. *(Call the names and present Gold and Silver Arrow Points to families to present to their boys.)*

Blue stands for truth. Truth comes through as a quality in our Cub Scouts who have completed the achievements for the rank of Bear. They have learned that Cub Scout honor is important and that truth is always the best. Will

the following boys and their families please come forward. *(Call the names and present the badges to families to give to their boys.)* After earning this rank, several boys have gone on to complete additional electives to earn Gold and Silver Arrow Points. *(Call the names and present the Gold and Silver Arrow Points.)*

Another meaning for the color blue is loyalty. This is an important quality a boy can develop in the process of becoming a man. Boys who have completed the requirements for the Webelos badge are developing this quality. Will the following boys and their families please come forward. *(Call the names and present the badges to families to give to their boys.)* Several of our Webelos Scouts have completed activity badges during the past month. Will the following boys please come forward. *(Call the names and present the badges.)*

Arrow of Light candidates prove that they are true to the gold and the blue by demonstrating the traits of our Cub Scout colors: good cheer, happiness, truth, and loyalty. They also show that they are striving toward the qualities of Boy Scouting by being trustworthy, loyal, helpful, friendly, courteous, kind, obedient, cheerful, thrifty, brave, clean, and reverent. Will the following boys and their families please come forward. *(Call the names and present the badges to families to give to their boys.)*

Let's show all these boys with a cheer how much we admire their efforts. *(Lead applause.)* Who's the best in blue and gold? Pack [number]!

## **Six Steps to Boy Scouting**

**Materials:** Holder with six candles or lights.

NARRATOR: We are here tonight to honor Cub Scouts who have advanced in rank since we last met as a pack. As he walks the achievement trail, the Cub Scout achieves many goals. These candles represent steps in his advancement. Their light stands for the help and encouragement given to him by his family, friends, and leaders.

*(Light Bobcat candle or light.)* First comes the Bobcat, the beginner. He learns the Cub Scout motto, the Cub Scout Promise, and the Law of the Pack. He stands with much enthusiasm on the first step of the advancement trail. As he climbs this trail, he grows in knowledge, skills, and fun. Will the following boys and their families please come forward. *(Call the names and present the badges to families to give to their boys.)*

*(Light Tiger Cub candle or light.)* Next comes the Tiger Cub. He completes five achievements each in three areas: Family, Den, and Go See Its. He has learned about the outdoors, where he lives, and health and safety. Will the following boys and their families please come forward. *(Call the names and present the badges to families to give to their boys.)*

*(Light Wolf candle or light.)* Next comes the Wolf Cub Scout, who completes 12 achievements in reaching the rank of Wolf. These require knowledge of the flag, about



fitness, tools, safety, and the environment. He has mastered several feats of skill, has made a collection, and has accomplished much more. Will the following boys and their families please come forward. *(Call the names and present the badges to families to give to their boys.)*

*(Light Bear candle or light.)* The Bear Cub Scout completes 12 achievements that show he is growing in knowledge and skills. The Bear Cub Scout is proud that he has climbed more than halfway up the Cub Scout achievement trail. Will the following boys and their families please come forward. *(Call the names and present the badges to families to give to their boys.)*

*(Light Webelos candle or light.)* When a Cub Scout enters the Webelos den, he begins the final stage of his climb up the trail. As a Webelos Scout, he works on a variety of activity badges that challenge him to do new things. Will the following boys and their families please come forward. *(Call the names and present the badges to families to give to their boys.)*

*(Light Arrow of Light candle or light.)* The Arrow of Light Award is the highest award in Cub Scouting and is the only Cub Scout rank that a boy may wear on his Boy Scout uniform. A boy who has earned the Arrow of Light is fully prepared to enter Boy Scouts. Will the following boys and their families please come forward. *(Call the names and present the badges to families to give to their boys.)*

As we walk this Cub Scout trail, may our steps be guided by the Cub Scout motto: Do Your Best.

## Value of a Badge

NARRATOR: A badge in Cub Scouting is a piece of embroidered cloth. It might not be worth a lot of money because the real value of the badge is in what it represents—the things you learned to earn it.

### For Bobcats:

NARRATOR: We have some boys who are to receive the badge of Bobcat and take their first step along the Scouting trail. Will the following boys and their families please come forward. *(Call the names and present the badges to families to give to their boys.)* To earn the badge of Bobcat, these boys learned the Cub Scout Promise, the Law of the Pack, the Cub Scout sign, and the Cub Scout motto. These things are part of the map that guide you along the Cub Scouting trail. As your families present this badge, please remember the value of this badge and the Cub Scout motto to Do Your Best.

### For Tiger Cubs:

NARRATOR: Will the following boys and their families please come forward. *(Call the names and present the badges to families to give to their boys.)* As you worked toward earning your Tiger Cub badge, you had the opportunity to take Go See Its and to work on advancement requirements at home and in your den. You learned about the outdoors, health and safety, and communication. Congratulations on your achievement.

Think about how your family helped you as your parents present to you the Tiger Cub badge.

### For Wolf Cub Scouts:

NARRATOR: Will the following boys and their families please come forward. *(Call the names and present the badges to families to give to their boys.)* As each of you worked toward your Wolf badge, you had the opportunity to develop new skills, help at home and in your community, and learn respect for our flag. You have completed the achievements for the Wolf badge. As your families present this award, think about how you will wear it with pride.

### For Bear Cub Scouts:

NARRATOR: Will the following boys and their families please come forward. *(Call the names and present the badges to families to give to their boys.)* As you worked toward your Bear badge, you found that the challenges became more difficult with each step. We all experience choices in our lives and must decide the best path to follow. To achieve the rank of Bear, you made choices as you selected which requirements to complete. As your families present this badge, think about the choices you make in your lives.

### For Webelos Scouts:

NARRATOR: Will the following boys and their families please come forward. *(Call the names and present the badges to families to give to their boys.)* As each of you joined the Webelos den, you faced new challenges and choices in working toward the Webelos badge. Your Webelos den leader now approves the completion of your requirements. Achievements are in the form of activity badges. As your family presents this award to you, think about the value of the Webelos badge and the changes that took place while you earned this award.

### Arrow of Light:

NARRATOR: Will the following boys and their families please come forward. *(Call the names and present the badges to families to pin on their boys.)* The trail to the Arrow of Light is a long and difficult trail to climb. It was full of adventure as you stretched to experience new challenges. Many of the achievements you accomplished have prepared you to move into Boy Scouts. These achievements have been new and varied with the promise of even greater adventures in the future. As your family places this award on your uniform, think about the adventures to come.

The Cub Scout trail is full of the traditions you learn as a Bobcat, the skills you learn as a Wolf Cub Scout, the choices you make as a Bear Cub Scout, the changes you experience as a Webelos Scout, and the adventures that challenge you while working toward the Arrow of Light. Think of the value of each badge you have earned. Each badge is a step-by-step adventure in your life along the Scouting trail. Remember the value of each of your badges.

## Woodworking

**NARRATOR:** Woodworkers use tools to transform plain wood into objects of beauty and usefulness. There are many steps between beginning to plan your project and displaying your completed masterpiece.

A woodworker has to start with a plan. Once he has a plan on paper, he uses the first saws to roughly shape the wood. Some of our Cub Scouts have earned the Bobcat badge and Tiger Cub badge that have begun to shape their Cub Scout experience. Will the following boys and their families please come forward. *(Call the names and present the badges to families to give to their boys.)*

The woodworker's next step is to finish cutting all the pieces so that they match the specifications on his plan. He then completes additional steps such as drilling and then shaping the edges. We have several Cub Scouts who have completed the steps for the Wolf badge. Will the following boys and their families please come forward. *(Call the names and present the badges to families to give to their boys.)*

Now the wood pieces are ready for the assembly process. This stage requires using dowels, screws, and glue to assemble the project. Patience and precision are needed. Some of our Cub Scouts have completed a tougher set of requirements for the Bear badge. Will the following boys and their families please come forward. *(Call the names and present the badges to families to give to their boys.)*

After the assembly, the surfaces of our project need to be sanded and prepared for the finishing treatment. Attention to details like these has led several of our Scouts to receiving the Webelos badge today. Will the following boys and their families please come forward. *(Call the names and present the badges to families to give to their boys.)*

The finishing touch to a fine piece of furniture is adding the stain and sealer. Our Arrow of Light recipients have demonstrated a commitment to becoming master craftsmen. Will the following boys and their families please come forward. *(Call the names and present the awards to families to give to their boys.)*

Our Cub Scouts and their families are certainly going to come out with a masterpiece with this advancement plan!

## Yule Log

**Materials:** A holder with a single candle or light.

**NARRATOR:** In the England of old, a Yule log was burned during the dark days of December to bring good luck. The ashes were then spread around the fruit trees for a good harvest.

In Germany, the Yule log was lighted at Christmas to scare away Father Frost.

In France, starting on Christmas Eve, it was an ancient custom to keep the Yule log burning through the days of Christmas until Twelfth Night. The log was carefully tended each night so it would last all 12 days. These customs were ways of wishing for good luck throughout the coming year.

Will the following boys and their families please come forward. *(Call the names.)* These boys have worked hard to bring out the Yule spirit by doing their best to earn their next badge. *(Present the badges to families to give to their boys.)*

I am lighting this candle that represents our pack Yule log as a sign of our joy and to wish each one of you best wishes and good luck in the coming year.

## Top of the Mountain (Arrow of Light)

**NARRATOR:** I'd like to tell you a story that was first told by Ernest Thompson Seton, one of the founders of Scouting in America.

There once was a high mountain that towered above a village. One day, the elder of the village asked the young men to start right after breakfast and to climb as high as they could. Their challenge was to climb until they were tired and then return with a twig from the place where they had turned back.

Away they went, filled with enthusiasm. Soon the first boy came slowly back, carrying a piece of cactus. The elder smiled and said, "My boy, you barely got started." I like to think that this boy is like a newly inducted Cub Scout. He has just barely started.

An hour later, the second boy returned carrying a twig of sagebrush. "Well," said the elder, "you reached a higher level but did not start the climb." This boy is like the Cub Scout who has earned his Bobcat badge. He has progressed on his journey but has not really started his climb.

After another hour, the third boy came back. He held out a cottonwood sprig. "Good," said the elder, "you reached the springs." This might represent the Cub Scout who has reached the first level of his climb and received his Tiger Cub badge.

After a longer wait, another boy came back with some buckthorn. The elder smiled and spoke: "You were climbing. You were up to the first slide rock." This is like the Cub Scout who has progressed nearly half way and has received his Wolf badge.

A while later, another boy came back with some cedar. The elder smiled and said, "Well done, my boy, you went halfway up." This is like the Cub Scout who has progressed halfway up the advancement trail and earned his Bear badge.

Later in the afternoon, the fourth boy returned carrying a branch of pine. To him the elder said: "Good, you went to the third level. Keep on trying. Next year, you will



surely reach the top.”The Cub Scout who has earned his Webelos badge is in sight of the top.

The sun was gone when the last boy returned. He approached the elder and held up his empty hand. He was radiant as he spoke:“My leader, there were no trees where I went. I saw no twigs, no living thing upon the peak. But far and away, I saw other mountains, and beyond them, the shining sea.”

The elder’s face glowed as he said:“I knew it when I looked upon your face. It is written in your eyes, and it rings in your voice. My boy, you need no twigs for token, you have seen the glory of the mountain.”

This boy who reached the peak is like the Webelos Scout who has reached the top—the Arrow of Light Award. But, beyond the top are the peaks of Boy Scouting that must be met and climbed to reach the shining sea beyond. I would like to now call the names of the Webelos Scouts and have their families present them their Arrow of Light Award.

### **Spirit of Scouting (Arrow of Light)**

**Materials:** Holder with four candles or lights (blue, white, yellow, green)

NARRATOR: Will the following Webelos Scouts please come forward with their families to receive the Arrow of Light Award. (*Call the names.*)

You have completed all the requirements for the Arrow of Light Award, the highest rank in Cub Scouting. You have also visited a Boy Scout troop and have discovered some of the excitement that awaits you.

*(Webelos den leader lights the blue candle or light.)* This blue candle [light] represents the spirit of Cub Scouting, that spirit of giving goodwill and doing your best.

*(Webelos den leader lights the white candle or light.)* This white candle [light] represents the spirit of Scouting. If you promise to fulfill the Cub Scout Promise and the Cub Scout motto, “Do Your Best,” please say, “I do.”

WEBELOS SCOUTS: I do.

NARRATOR: This yellow candle [light] represents the Arrow of Light Award.

*(Webelos den leader lights the yellow candle or light.)* Remember that the spirit of Cub Scouting and Boy Scouting are one and the same. The spirit of the entire Scouting movement is one of service, high ideals, and fellowship. To each family, I am presenting the Arrow of Light Award and ask you to give this to your boy. This award is worn on the Webelos uniform and on the Boy Scout uniform later. (*Present badges to the families.*)

Notice that we are leaving unlit the green candle [light] representing the Boy Scout program. This is to remind you that there is more adventure ahead as you continue in Boy Scouts. Good luck to you and your families as you walk the Scouting trail.

# CHAPTER 9

## Transition Ceremonies

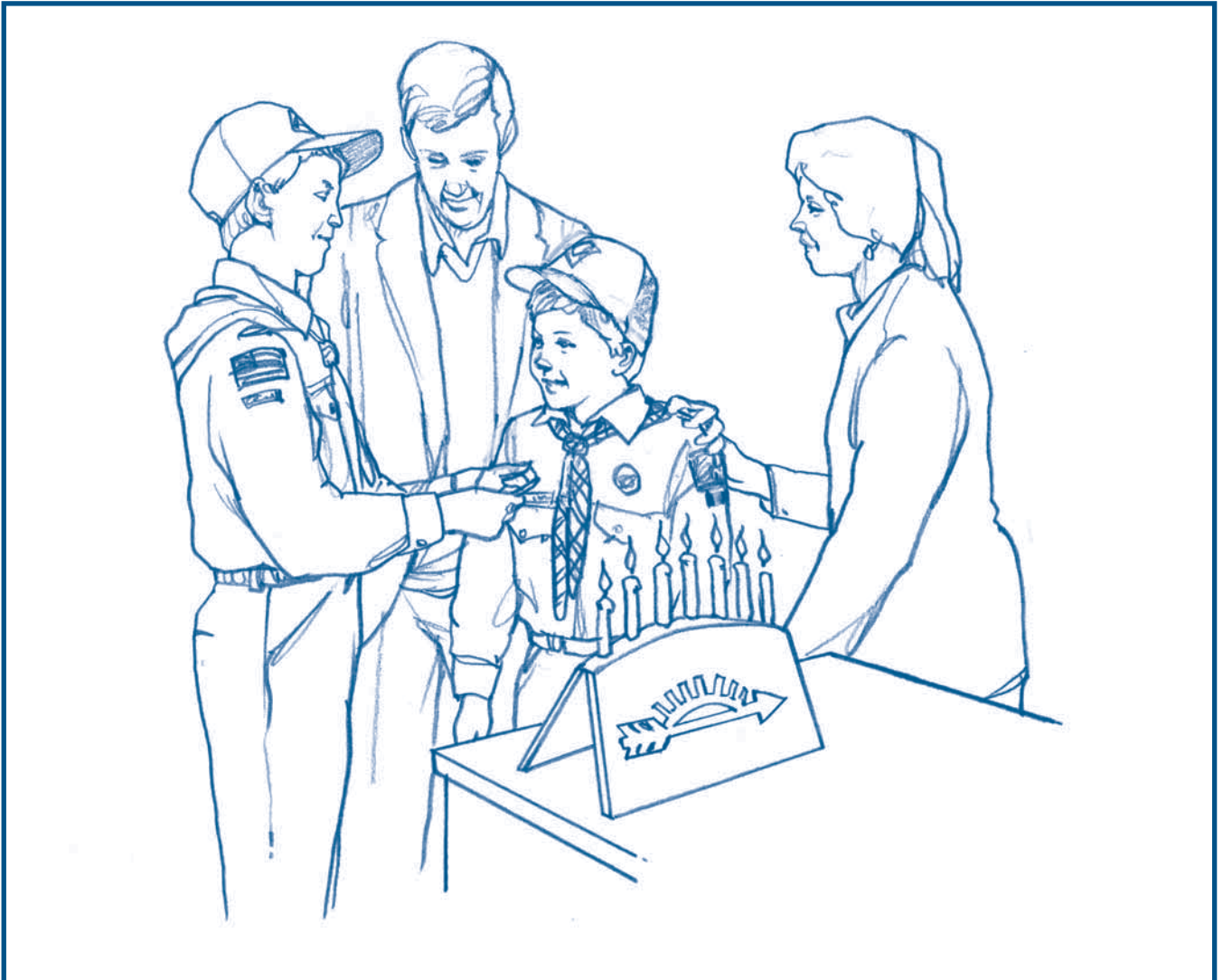

Let's Have a Celebration! 9-2

Timing Is Everything, 9-2

Who Plans the Ceremony? 9-2

The Cub Scout Cycle, 9-2

Ceremonies

Akela Transition Ceremony for Tiger Cubs, 9-3

Mark of the Tiger, 9-3

Neckerchief Ceremony, 9-3

Bear Trail Adventure, 9-3

Four Winds, 9-4

Colors of the Wind, 9-4

Seven Virtues of Life, 9-4

Cub Scout Trail, 9-5

## Let's Have a Celebration!

Do you remember what it feels like to move into a new class in school? There is some fear on one hand and excitement on the other. When we celebrate the moment of a boy's transition from Tiger Cubs to Wolf or Webelos Scouts to Boy Scouts, it helps smooth that adjustment. In fact, why not celebrate each step: Tiger Cub to Wolf, Wolf to Bear, Bear to Webelos Scout, and Webelos Scout to Boy Scout. Next to receiving a rank badge, there is no stronger memory in a boy's Scouting experience than a transition ceremony.

Be careful to make all of your props "barrier-free." A bridge from Cub Scouts to Boy Scouts could prevent someone who is visually or physically impaired from participating with the den. Instead of making the boy feel different, adapt the plan so that all boys have this experience in the same way. Make freestanding holders for a rope, suggesting a bridge, instead of raising the floor. Use your imagination.

## Timing Is Everything

When do you transition your Cub Scouts and start their work on the next rank? The Cub Scout cycle recommends that Tiger Cubs, Wolf Cub Scouts, and Bear Cub

Scouts transition into the next program at the end of the school year. This gives them the opportunity to work in their new books during summertime activities.

It is important that Webelos Scouts receive the Arrow of Light by the end of February and then begin attending Boy Scout troop meetings in March. They need to have time to develop friendships and skills before attending summer camp with their troop. Boy Scouts who attend summer camp their first year are much more likely to stay in Scouting than those who miss out on this opportunity.

## Who Plans the Ceremony?

The responsibility of planning the transition ceremony belongs to many people in the pack and should be discussed at a pack leaders' meeting. The key is to involve as many people as possible, with one person leading the group. Use your parents, Cubmaster, assistant Cubmasters, Tiger Cub den leaders, Cub Scout den leaders, Webelos den leaders, den chiefs, and Scoutmasters. In other words, involve the people who have played an important part in providing the Cub Scout program for the boys. When you schedule these events ahead of time during your annual pack program planning conference, you'll be sure to make it a memorable and impressive event.

## The Cub Scout Cycle (with February transition of fifth-grade Webelos Scouts)

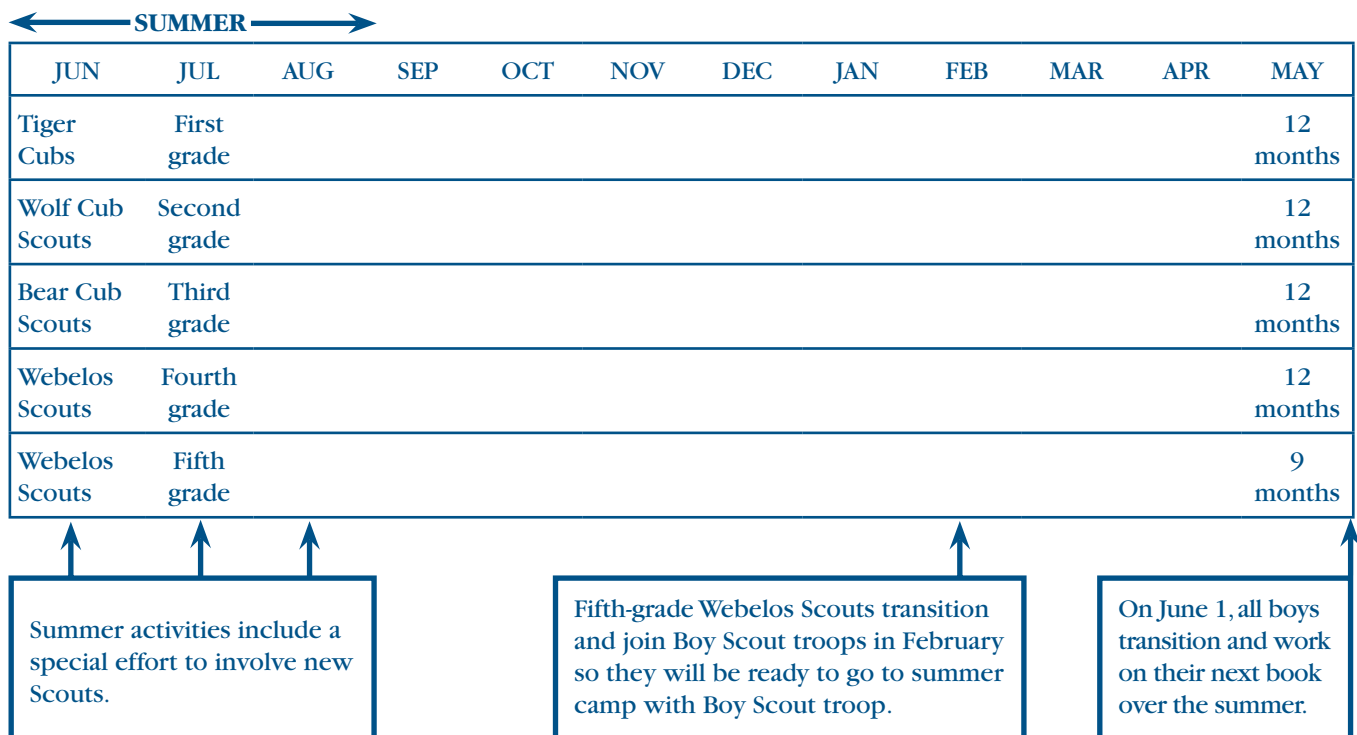

**April and May:** Selecting the best possible den and pack leaders is critical. Carefully identify and recruit next year's leaders now so that they can help current leaders and transition into their new roles.

## Akela Transition Ceremony for Tiger Cubs

**Preparation:** Lay a path with tracks of a tiger from where the Tiger Cub den is seated to the area where the ceremony will be held.

**Materials:** Tiger tracks made from black construction paper, electric campfire, a Tiger Cub emblem, and a homemade certificate for each boy.

CUBMASTER: Come to the council fire, those of you who wish to become Wolf Cub Scouts. As I call your name, come follow the trail of the tiger to our campfire. *(Call the names of Tiger Cubs and their adult partners.)* You have earned the Bobcat badge. For the past year, you have learned about making your family special, citizenship, how to keep yourself healthy and safe, communicating, and outdoor program.

TIGER CUB DEN LEADER: Along this trail, you were helped and guided by your Tiger Cub adult partner.

CUBMASTER: Now it is time to begin a new trail, a new path, a new adventure in Cub Scouting. You will be entering the Wolf Cub Scout den and following the trail to the Wolf badge. May the Great Spirit always be by your side as you follow the Cub Scout motto: Do Your Best!

## Mark of the Tiger (Tiger Cub to Wolf Cub Scout)

**Materials:** Orange or black marker and poster.

NARRATOR: Today, we honor our Tiger Cubs. Will the following boys and their adult partners please come forward. *(Call the names.)* On behalf of our pack, Tiger Cub Den Leader [Name] would like to recognize your journey this year.

TIGER CUB DEN LEADER: During the past months, you and your families have explored new and exciting things and places. You have taken part in den and pack meetings, and taken field trips called Go See Its. *(Draw the pad of the tiger paw on the poster.)*

You and your partner have searched out new activities that have shown you how people work and have fun together. *(Draw the first toe.)*

You have discovered that by doing things together with friends and family, you feel a sense of belonging. *(Draw the second toe.)*

You have shared with your family, friends, and fellow Tiger Cubs the things that you have searched out and discovered, which helped them learn more about you. *(Draw the third toe.)*

In Cub Scouting, your family is important, just as it is throughout your whole Scouting experience. Support in earning each badge comes from your family as well as from your den leader. Your family will help you each step of the way. *(Draw the fourth toe.)*

On behalf of our pack, I want to congratulate you as you move to the next step of Scouting! Let's give them a round of applause and congratulate them!

## Neckerchief Ceremony

**Materials:** Tiger Cub, Wolf, Bear, Webelos, and Boy Scout neckerchiefs on display; a neckerchief for each boy for his next rank.

NARRATOR: Today, we have the privilege of watching our Scouts take a step toward their next station on the Cub Scouting trail.

Will the Tiger Cubs and their families please come forward. During the past year, you have worked hard. As you start on the trail of the Wolf, you will wear the yellow neckerchief, which reminds you of the happiness, good cheer, and warm sunshine of the Cub Scout Promise. *(Remove the Tiger Cub neckerchiefs and replace with Wolf Cub Scout neckerchiefs.)* Pack [number], I would like to present to you your new Wolf den.

Will the Wolf Cub Scouts and their families please come forward. You have worked hard this past year on the achievements and electives for the Wolf rank. The next neckerchief you will wear is blue to remind you of the truth in the Law of the Pack. *(Present mementos.)* Pack [number], I would like to present to you your new Bear den.

Will the Bear Cub Scouts and their families please come forward. The Webelos program has more challenges ahead for you. The plaid neckerchief you will wear is multicolored, combining the blue and gold of the Cub Scout program with the red and green of the Boy Scout program. *(Present mementos.)* Pack [number], I would like to present to you your new Webelos den.

May you walk the Cub Scouting trail with pride and live the Cub Scout Promise and Law of the Pack.

## Bear Trail Adventure (Wolf Cub Scout to Bear Cub Scout)

**Preparation:** Make a bear paw for each boy and write "God, Country, Family, Self" on each.

NARRATOR: We have some Cub Scouts who are getting ready to embark on a new adventure! Will the following boys please come forward. *(Call the names of transitioning Wolf Cub Scouts.)* You have accepted the challenges that were sent your way this past year and mastered them. Are you ready to walk a new trail? *(Boys say "yes.")*

This trail will have choices for you to make. There are lots of achievements, and you will be making choices in four areas: God, country, family, and self. The choices you make will shape your future trails. If you accept this new challenge, please make the sound of the bear. *(Boys roar.)* Here is a bear paw to remind you of the challenge ahead. *(Present a paw to each boy.)*



## Four Winds (Bear Cub Scout to Webelos Scout)

**Materials:** Holder with five candles or lights.

NARRATOR: *(Have someone dim the lights.)* Tonight, we have some Cub Scouts who are ready to join a Webelos den. Will the following boys and their families please come forward. *(Call the names.)*

*(Have the Webelos den leader light the first candle or light.)* The winds can be both our friends and our enemies. They can bring rain clouds with much needed moisture or heavy storms that damage our crops. Today, they are bringing us messages of goodwill. Listen to what they are saying.

BEAR DEN LEADER: I am the north wind. People say that I am cold, but I will always bring you the warmest of winds because you live up to the Law of the Pack. *(Webelos den leader lights the second candle or light.)*

I am the south wind. I wish you good Scouting and carry stories of your Cub Scouting achievements throughout the land. *(Webelos den leader lights the third candle or light.)*

I am the east wind. I spread the story of your Scouting spirit and tell how you live up to the Cub Scout Promise. *(Webelos den leader lights the fourth candle or light.)*

I am the west wind. I guide families to help these Cub Scouts. They do not walk the trail alone. Each has the help of his family. *(Webelos den leader lights the fifth candle or light.)*

All the winds are wishing you the best of luck on the Webelos trail toward the Arrow of Light.

NARRATOR: Congratulations! Let's all welcome these new Webelos Scouts!

## Colors of the Wind (Webelos Scouts to Boy Scouts)

**Materials:** Holder with four candles or lights (blue, yellow, white, and red). Webelos den leader lights the candles. Have a trail ready if you are using one in this ceremony.

NARRATOR: Tonight, we are honoring some Webelos Scouts who are moving forward along the Scouting trail. Will the following boys please come forward. *(Call the names.)*

Today, you are making a giant step—that from Cub Scouting to Boy Scouting. As we present to you the colors of the four winds, remember them, and let them continue to guide you along the Scouting trail.

*(Light the blue candle or light.)* Blue stands for the Cub Scout spirit and the north wind. You are a true blue Cub Scout and live up to the Law of the Pack.

*(Light the yellow candle or light.)* Yellow stands for the south wind that carries the story of your achievements far and wide. As a Cub Scout you have been eager, fair, and a credit to your den and pack.

*(Light the white candle or light.)* White stands for the east wind and the spirit of Scouting. The east wind carries the story of your fun and happiness to your Scout troop and tells others how you live up to the Cub Scout Promise.

*(Light the red candle or light.)* Red stands for the west wind and represents the families of these Webelos Scouts. It tells of the help and guidance that these Webelos Scouts receive from their families. Continue to help your boy go and grow as he continues to walk the Scouting trail in Boy Scouting.

As you cross into Boy Scouting, we'll give you the Cub Scout handshake one last time. *(The Cubmaster and Webelos den leader shake hands with the Webelos Scout. The boy walks to the Scoutmaster, giving him and the senior patrol leader the Scout handshake.)*

## Seven Virtues of Life (Webelos Scouts to Boy Scouts)

**Materials:** Holder with seven candles or lights, troop neckerchief (if one is going to be presented; if the neckerchief is not going to be presented, reword the ending of the ceremony).

NARRATOR: Will the following Webelos Scouts please come forward. *(Call the names.)* Today, we are honoring these boys who have brought honor to our pack as they climbed the Cub Scout trail. They are now ready to go into Boy Scouting. With the help of their families, they will soon start walking the Boy Scout trail.

WEBELOS DEN LEADER: The seven candles [lights] before you represent the rays in the Arrow of Light. As they are lighted, you will hear how they stand for the seven great virtues of life. *(The narrator lights the candles or lights.)*

1. Wisdom doesn't mean that you are smarter than others. It means that you use what you know to lead a better life.
2. Courage doesn't mean that you have no fear of danger. It means that you can face danger despite your fear.
3. Self-control means being able to stop when you have had enough of something, such as eating, playing, or even working too much.
4. Justice means being fair with others as you play and work with them.
5. Faith is belief in God and things you cannot see but feel are true.
6. Hope means to look forward to good things you believe will happen and work hard today to make them happen.
7. Many kinds of love are important: love of family, fellow humans, God, and our country.



NARRATOR: If you live by these virtues, you will be a happier person. Scoutmaster [Name] is here to receive you into your troop. *(Scoutmaster says a few words of welcome.)*

SENIOR PATROL LEADER: As you remove your Cub Scout neckerchief, remember the things you learned in Cub Scouting. And as you wear this Boy Scout neckerchief, remember that it represents the members of our troop who always try to do their best and be prepared. Welcome to our troop. *(He gives each boy a Scout handshake.)*

## **Cub Scout Trail (Webelos Scouts to Boy Scouts)**

**Preparation:** Any Cub Scout holds a Bobcat badge, a Tiger Cub holds a Tiger Cub badge, a Wolf Cub Scout holds a Wolf badge, a Bear Cub Scout holds a Bear badge, a Webelos Scout holds a Webelos badge, a den chief holds an Arrow of Light Award, a Scoutmaster or senior patrol leader holds a Boy Scout badge. Space the badges apart so that they form a trail. This ceremony can be done inside or outside (arrange them around the edge of a clearing).

NARRATOR: Tonight, we are honoring some Webelos Scouts who are moving forward along the Scouting trail. Will the following boys please come forward. *(Call the names.)*

You are taking a giant step—that from Cub Scouting to Boy Scouting. We would like to think back on some of the steps you have taken along the way.

*(Walk with the boys to the Bobcat station.)* Remember when you first joined Cub Scouts? The Cub Scout motto, Law of the Pack, and the Cub Scout Promise were new to you then.

*(Walk with the boys to the Tiger Cub station.)* Your first year in Cub Scouting, you did lots of activities with your families. You went on Go See Its, you did family projects, and you shared new ideas in your den.

*(Walk with the boys to the Wolf station.)* At this stop, you worked on achievements that included knowledge about the flag, fitness, tools, safety, and feats of skill.

*(Walk with the boys to the Bear station.)* While working on the Bear badge you completed achievements in four areas: God, country, family, and self. You were able to choose which achievements to complete.

*(Walk with the boys to the Webelos station.)* As Webelos Scouts, you worked on activity badges. You learned the different parts of the Webelos uniform, the Outdoor Code, and furthered your knowledge about your duty to God. You began to discover the meaning behind the Scout Oath and Scout Law.

*(Walk with the boys to the Arrow of Light station.)* To earn the highest award in Cub Scouting, you committed yourself to living the Scout Oath and Scout Law. You learned about the Boy Scout uniform. You may have gone on a Webelos den overnight campout [or day hike] and visited a Boy Scout troop meeting [or activity].

*(Walk with boys to the Boy Scout station.)* And now you have reached the beginning of a new trail. I would like to introduce your new Scoutmaster and senior patrol leader. *(The Scoutmaster and senior patrol leader take a few moments to welcome the new Boy Scouts.)*



# CHAPTER 10

## Other Opportunities for Ceremonies

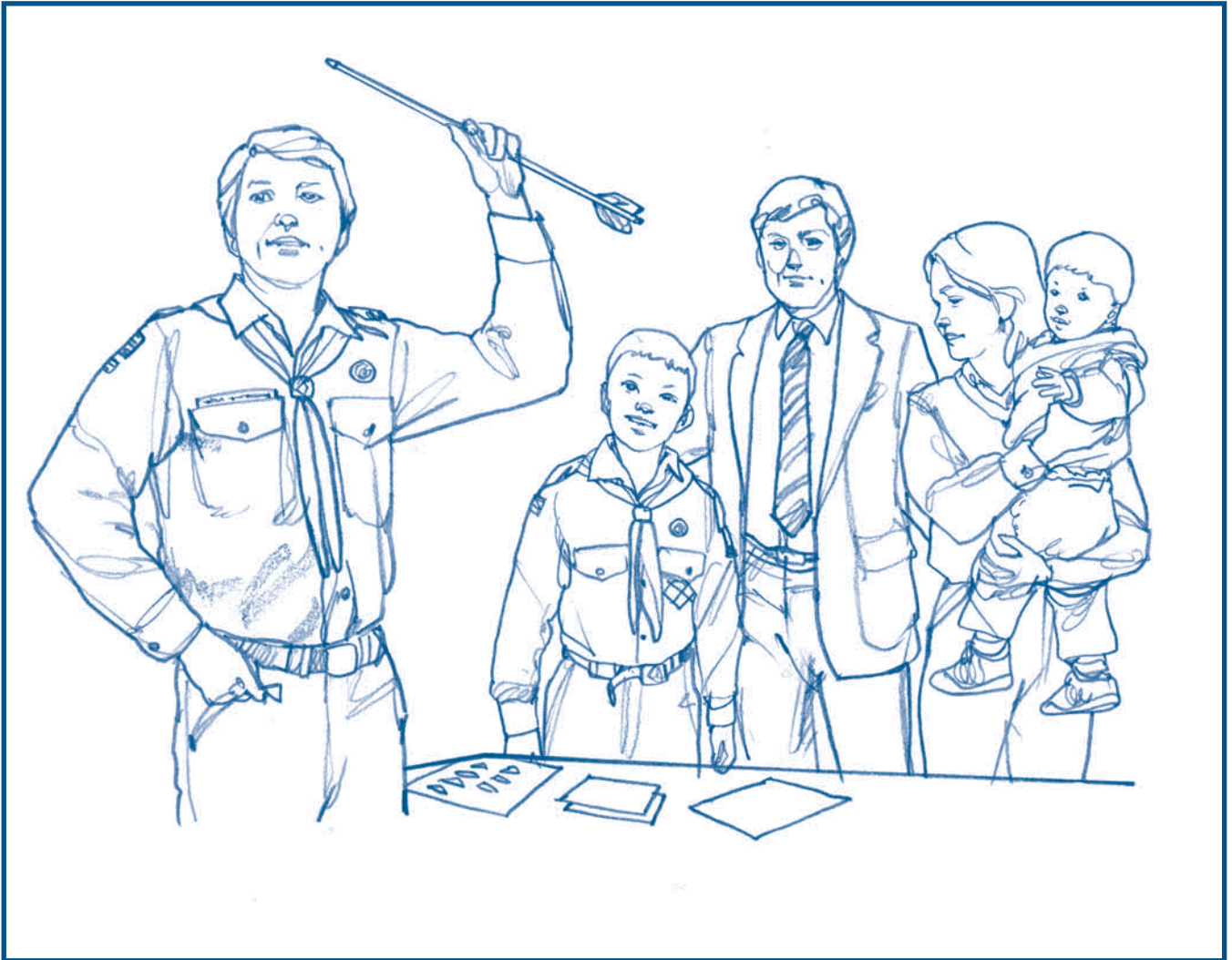

**Are There Other Times for Recognition? 10-2**

**Webelos Activity Badge Presentation, 10-2**

**Ceremonies**

**Tiger Cub Immediate Recognition Emblem, 10-2**

**Gold and Silver Arrow Points, 10-2**

**Webelos Activity Badge With Colors or Cap, 10-2**

**Webelos Activity Badge With Samples, 10-3**

**Academics and Sports Awards, 10-3**

**Den Service Projects, 10-3**

**World Conservation Award, 10-3**

**National Den Award, 10-3**

**Service Stars (Tenure Award), 10-3**

**Twelve Months of Scouting  
(National Summertime Pack Award), 10-4**

**Centennial Quality Unit Award, 10-4**

**Pack Charter Presentation, 10-4**

**Silver or Gold Pack Anniversary Ceremony  
at the Blue and Gold Banquet, 10-5**

**The All-Purpose, All-Occasion Ceremony Creator, 10-5**

## Are There Other Times for Recognition?

Definitely! More ideas follow on the next few pages.

- Tiger Cubs earn Tiger Track beads by completing electives.
- Cub Scouts earn Gold and Silver Arrow Points by completing electives.
- Webelos Scouts have the opportunity to earn 20 activity badges.
- The Cub Scout Academics and Sports program has many areas where boys and their adult partners can be recognized for their efforts and talents.
- The Fun for the Family Award recognizes families with a certificate, patches, and pins for working on this program together.
- The pack can recognize its own efforts in presenting a quality program during the past year.

Your ceremonies will focus on everyone's accomplishments and will build den and pack spirit. Use your imagination to develop and adapt ceremonies for your boys.

## Webelos Activity Badge Presentation

Webelos Scouts will earn a variety of activity badges during their time in a Webelos den: Aquanaut, Artist, Athlete, Citizen, Communicator, Craftsman, Engineer, Family Member, Fitness, Forester, Geologist, Handyman, Naturalist, Outdoorsman, Readyman, Scholar, Scientist, Showman, Sportsman, and Traveler.

The Webelos den program will be focusing on one of these areas each month, so it may happen that you will have several boys who have earned the same activity badge. If the Webelos den has worked with an activity badge counselor, involve this person in the presentation of the badges. That counselor will have a working knowledge of what was involved in earning the awards and will be able to help develop a more meaningful ceremony.

### Tiger Cub Immediate Recognition Emblem

**Preparation:** Learn the man overboard knot in Achievement 22 of the *Bear Handbook*.

**Materials:** Rope and Tiger Cub Immediate Recognition Emblem for each boy

**CUBMASTER:** Throughout Scouting, there is a strong emphasis on strengthening family relationships. This is particularly true in Tiger Cubs. We take a first-grade boy full of enthusiasm and curiosity. (*Hold up a rope and make the first loop for the man overboard knot.*) And add an adult partner (*make the second loop*) to make our first Tiger team. We add other teams (*make more*

*loops*) to make a Tiger Cub den. Then we take our Tiger Cub program by the tail and thread our teams together securely. (*Thread the tail of the rope through all the loops.*) And if we have done our best and provided a program to spark the spirit of Scouting, then we'll find we have a string of strong families. (*Pull the rope to form the knots.*)

**TIGER CUB DEN LEADER:** Cubmaster, these Tiger Cubs are beginning their first year in Scouting and have learned the Cub Scout Promise, the Cub Scout sign, and the Cub Scout salute. (*Call the boys and their adult partners forward. Lead all in reciting the Cub Scout Promise.*) Because you have learned these things, you may wear the Tiger Cub Immediate Recognition Emblem on your right shirt pocket. (*Present the emblems.*)

**CUBMASTER:** Congratulations on completing this first step of the Scouting trail. As you do activities with your den and family, you will receive special orange, black, and white activity beads to attach to your new emblem. As you complete elective activities, you will receive yellow Tiger Track beads. May the fun you have in Tiger Cubs bring your family closer together as you live the Cub Scout motto.

### Gold and Silver Arrow Points

**Materials:** An arrow

**NARRATOR:** Today, we honor some Cub Scouts who have gone the extra mile and have earned Gold and Silver Arrow Points. Will these boys and their families please come forward. (*Call the names.*)

(*Hold the arrow in the air.*) Have you ever shot an arrow? What do you think makes the arrow fly straight? (*Point out the straight shaft and the feathers.*) What helps it enter its target? (*Tell them: A good aim and a sharp point.*)

The arrow must be straight and true with feathers for guidance and stability, and it also must be fast and sharp. To be a good Cub Scout, you too must remain straight and true and receive guidance and stability from Akela. Congratulations on reaching your target and earning these Arrow Points. (*Present awards.*)

### Webelos Activity Badge With Colors or Cap

**Preparation:** Create a generic prop that is a large Webelos colors or Webelos cap. It can be made of fabric or a sheet of poster board that has been colored to match. Enlarge a line drawing of each activity badge and copy the requirements for that badge on the back. Throughout the year, use them as you present badges. Involve the Webelos den leader or activity badge counselor in the presentations.

**NARRATOR:** Today, we have the honor of recognizing Webelos Scouts who have earned Webelos activity badges since our last pack meeting. Will the following boys please come forward.

[Names] have earned the [name of an activity] badge. Requirements for this badge include [list some requirements]. What was most memorable about earning this badge? *(The boys respond.)*

*(Continue if more than one activity badge was earned.)*

Congratulations on completing this step along your Scouting trail toward the Arrow of Light Award.

## Webelos Activity Badge With Samples

**Preparation:** Webelos Scouts bring samples of their projects for the activity badge.

WEBELOS DEN LEADER: Our den has been working at home and in our den meetings on the [name] activity badge. Several of the Webelos Scouts have completed the requirements and have earned this badge. Will the following Webelos Scouts please come forward. *(Call the names.)* With us tonight is [Name of person], the activity badge counselor, who will present the badges.

ACTIVITY BADGE COUNSELOR: It has been my pleasure to work with these Scouts on this activity badge. They have brought some samples of their work to show you. *(Boys show what they have been working on.)* I take great pleasure in presenting these *(name of badge)* activity badges. Congratulations!

## Academics and Sports Awards

**Preparation:** Insert the awards in an old newspaper.

NARRATOR: *(reading newspaper)* Help wanted. Boy who likes challenges, enjoys life, has fun, loves adventure, can follow rules, and is a good sport.

Will the following boys please come forward. *(Call the names.)* It sounds like you qualify for this position! You have earned your Cub Scout Sports award for [list requirements]. *(Present the Sports awards.)*

*(Narrator continues reading the newspaper.)* Help wanted. Young man who has a good imagination, is skilled in [list academic talents], and practices his talents. Will the following boys please come forward. *(Call the names.)*

You sound just like the people we need. You have completed all the requirements for an Academics award. *(Present the Academics awards.)*

Let's congratulate our Scouts who jumped right up and really answered these want ads!

## Den Service Projects

**Preparation:** Create a fun award for the den doodle (See examples in Chapter 3.)

NARRATOR: Service to others has been a part of the Scouting program since it first started. Will the Cub Scouts and leaders of Den [number] please come forward. Please share with us how your den helped other people. *(Allow the boys some time to share what they did.)*

We'd like to present you with a den award for your den doodle. This is a [name the award] for [say why the den is receiving it]. (Examples: Flashlight on a string for lighting the way, compass on a string for leading the way, tent stake on a string for your stake in the future.) Let's show them our appreciation. *(Lead an appropriate applause.)*

## World Conservation Award

**Materials:** World Conservation Award for each boy

NARRATOR: In his last letter to Scouts around the world, Lord Baden-Powell, the founder of Scouting, wrote, "Try to leave the world better than you found it."

DEN LEADER: Today, we are honoring some Scouts who have worked hard to fulfill the requirements of the World Conservation Award. Will the following boys please come forward. *(Call the names.)* These boys have completed achievements and electives related to the outdoors in addition to completing a den conservation project. Would you like to explain your project to our pack? *(Let the boys share the explanation of their project.)*

NARRATOR: Thank you for helping make our world a better place for all of us. *(Present the awards.)*

## National Den Award

**Materials:** National Den Award ribbon for the den

NARRATOR: Cub Scouting happens in the den. We have a den that has been on the ball with a year-round fun and quality program. Will the Cub Scouts and leaders of Den [number] please come forward. *(Pause.)* The boys in this den have attended den meetings and pack meetings or pack activities each month of the year. They have also had a denner, gone on field trips, attended camp, experienced Character Connection activities, participated in Cub Scout Academics and Sports, and had fun in a den conservation or service project.

On behalf of the pack committee for Pack [number], I am pleased to present them with this National Den Award ribbon for their den flag. Let's congratulate them with an applause. *(Lead an appropriate applause.)*

## Service Stars (Tenure Awards)

**Preparation:** Cut out a star for each person receiving a tenure award and write his/her name on it. Insert the service star showing the correct number of years of service.

NARRATOR: Have you ever watched shooting stars in the sky? You usually don't see just one. When the conditions are favorable, you usually see a bunch of them falling one at a time. We have some stars of our own tonight. The conditions have been favorable for each of these Scouts and leaders to complete a year of Scouting in our pack. Will the following people please come forward. *(Call the names.)*



Tiger Cub, Cub Scout, and Webelos Scout time is marked with a yellow backing behind the pin showing the number of years. Adult leaders can wear separate pins for their time in Scouting as a youth, or combine their time with that of their adult leader service in front of a light blue backing.

These pins are worn three-eighths of an inch above the left shirt pocket on the uniform. Congratulations!  
*(Present the awards.)*

## **Twelve Months of Scouting (National Summertime Pack Award)**

**Materials:** Holder with one candle or light, 12 boys holding flashlights standing behind the narrator, a copy of the *Den & Pack Meeting Resource Guide* and *Webelos Leader Guide*, National Summertime Pack Award ribbon for each den that has qualified, a pin for each boy who qualifies *(Note: This award is for boys only, not adults.)*

NARRATOR: *(Light the single candle or light and have someone dim the lights.)* This light represents the spirit of Scouting. These 12 boys represent the 12 months of a year in the life of an active boy.

This year our pack has used the Core Values: *(Hold up the Den & Pack Meeting Resource Guide and Webelos Leader Guide and read the Core Values your pack has used for the past year. As you read each month, have a boy turn on his flashlight and shine it on the floor in front of him.)*

This is what happens when pack leaders plan a full 12-month program of activities. If we were to take the summer off from Scouting *(have three boys turn off their flashlights)*, we would have lost one-quarter of our light—and one-quarter of our boys' Cub Scout program. But, by sticking to our plan *(the three boys turn on their flashlights again)*, our Cub Scouts had a full year of fun and adventure.

Our pack planned and conducted three pack activities that occurred in June, July, and August. I'm pleased to present this streamer we have received for our pack flag. *(Present the streamer to the Cubmaster.)*

Will the following den leaders please come forward. *(Call the names.)* Your dens had an average attendance of at least half of your members at the three summer pack events. I would like to present you with a den participation ribbon for your den doodle. *(Present the ribbons to the leaders.)*

Will the following Scouts please come forward. *(Call the names.)* Each of you participated in all three of the pack summertime events and has earned this pin that you can wear on the right pocket flap of your uniform. *(Present the pins.)* Let's give our pack a special applause!

## **Centennial Quality Unit Award**

**Materials:** Centennial Quality Unit streamer for the pack flag, Centennial Quality Unit Award for adults and boys

UNIT COMMISSIONER: I'm here today to recognize Pack [number] as one of the best packs in our district, in our council, in our region, and in our nation. Your pack has earned the distinction of being a Centennial Quality Unit. Will Cubmaster [Name] please come forward.

Your pack leaders have completed training and have planned activities that meet the test of being a Centennial Quality Unit. On behalf of the [local council name], I am pleased to present you with this streamer for your pack flag. Congratulations!

CUBMASTER: Each leader and Scout in our pack shares the honor of this distinction because together they have done their best. I would like to present each one of them with the Centennial Quality Unit Award, which they can wear for the following year on their right sleeve, 4 inches below the shoulder seam. *(The boys and leaders come forward.)* Let's give our pack a special applause!

## **Pack Charter Presentation**

**Preparation:** The unit commissioner conducts the presentation of the pack charter to a representative of the chartered organization at one of its meetings. Four boys carry lights that can be turned on.

CUB SCOUT 1: This light represents the spirit of Scouting. *(He turns on his light.)*

CUB SCOUT 2: I promise to do my best to do my duty to God and my country. *(He turns on his light.)*

CUB SCOUT 3: I promise to do my best to help other people. *(He turns on his light.)*

CUB SCOUT 4: I promise to do my best to obey the Law of the Pack. *(He turns on his light.)*

UNIT COMMISSIONER: In presenting this unit charter to [name of organization], I would like to congratulate you on the way you have assumed and carried out your responsibilities as the chartered organization for Pack [number]. I want to express the appreciation of the [BSA Council's name] for the cooperation that you have given in extending this program to youth.

Congress has chartered the Boy Scouts of America since 1916. The Boy Scouts of America, in turn, charters your organization to carry out the full Scouting program. It is with a great deal of pleasure that I now present you the charter for Cub Scout Pack [number] for [year]. *(Present the charter.)* I wish your pack a successful Scouting program in the coming year.

CUB SCOUT 1: The Cub Scout follows Akela.

CUB SCOUT 2: The Cub Scout helps the pack go.

CUB SCOUT 3: The pack helps the Cub Scout grow.

CUB SCOUT 4: The Cub Scout gives goodwill.  
(*Extinguish lights.*)

### **Silver or Gold Pack Anniversary Ceremony at the Blue and Gold Banquet**

**Materials:** Holder with four candles or lights—white, blue, yellow, and silver or gold. Your pack charter will tell how many months your unit has been continuously chartered.

CUBMASTER: Welcome to the Pack [number] Blue and Gold Banquet.

CUB SCOUT: I am lighting this white candle, (*lights it*) which represents the spirit of Scouting.

ASSISTANT CUBMASTER 1: I am lighting this blue candle, (*lights it*) which represents truth, loyalty, and the sky above.

ASSISTANT CUBMASTER 2: I am lighting this yellow candle (*lights it*) representing good cheer, happiness, and warm sunlight.

COMMITTEE CHAIR: I am lighting this silver (or gold) candle (*lights it*) representing the 25 [or 50] years that our pack has served our youth.

CUBMASTER: These four candles symbolize our traditions and dedication to the Cub Scout program. If we went back and counted each boy and adult who has been registered with our pack, we would have an impressive number to give you. But think even beyond that. We could never count the effect that these people have had on their communities and on future generations. Let's all stand, give the Cub Scout sign and say the Cub Scout Promise together.

## **The All-Purpose, All-Occasion Ceremony Creator**

Choose one or more phrases from each area. Add your own personal words for each occasion.

1. Will the following \_\_\_\_\_ please come forward. (Tiger Cubs, Cub Scouts, Webelos Scouts, special guests, leaders, families, dens, other: \_\_\_\_\_)
2. Before you stands \_\_\_\_\_. (A candle, a light, a Cub Scout handbook, Akela, a ladder, a neckerchief, a trail, your leader, a bucket, a tripod, a religious symbol, a bridge, a box, the pack, a branch, a picture, your parents, other: \_\_\_\_\_)
3. This represents \_\_\_\_\_. (The spirit of Scouting, the pack, your future, our dedication, character, fun and adventure, our religious organization, your den, your advancement, fitness, the family, good deeds, your accomplishments, the world, our community, other: \_\_\_\_\_)
4. You have earned this award by \_\_\_\_\_. (Helping others, joining the pack, being the best \_\_\_\_\_, doing your best, completing achievements, collecting \_\_\_\_\_, helping boys grow, helping with \_\_\_\_\_, serving as \_\_\_\_\_, being a denner, selling the most \_\_\_\_\_, serving for \_\_\_\_\_ years, other: \_\_\_\_\_)
5. Please accept this award and continue to \_\_\_\_\_. (Do your best, give goodwill, help the pack go, come to meetings, follow Akela, help your boy, work hard, grow strong, follow the trail, other: \_\_\_\_\_)
6. Will the pack please join me in congratulations for this award. (Lead an appropriate applause.)



# CHAPTER 11

## Outdoor and Campfire Ceremonies



Scouting Goes Outdoors, 11-2

Things to Remember, 11-2

### Ceremonies

Campfire Lighting, 11-2

Campfire and Candles, 11-2

Invocation of the Fire, 11-2

Outdoor Code, 11-2

Campfire Advancement, 11-3

Circle of Light, 11-3

Benediction, 11-3

Irish Blessing, 11-3

Light of Day Has Left Us, 11-3

## Scouting Goes Outdoors

Remember that the outdoor program runs like a thread through the Scouting program. When dens and packs are outdoors, ceremonies are appropriate—and important! Outdoor pack activities can start with an opening ceremony and end with a closing ceremony or closing campfire. If an outdoor pack activity is replacing the monthly pack meeting, there should also be an advancement ceremony so that awards can be presented promptly.

## Things to Remember

When planning an outdoor ceremony, consider these details ahead of time:

- Weather can make it difficult to keep candles lit. Have a backup plan and always remember fire safety rules.
- Outside noises from wind and water can make it difficult to hear voices. Keep the group close together and have the speaker face the crowd.
- Plan your flag ceremony carefully. If you do not have a secure flag holder, have the boys present the flag and continue to hold it during your flag ceremony. Then have them retreat with the flag. Whether we are inside or outside, we give the U.S. flag the same respect and handle it properly.
- Use nature as a backdrop. Look around and choose a location that showcases your event.
- Sweep the area and walkways, looking for loose rocks and tree roots that might trip a boy or adult.
- If you are using a campfire, learn and follow the rules for fire safety.
- Flashlights or glow sticks work well as alternatives to candles in outdoor ceremonies.
- Keep ceremonies short!

## Campfire Lighting

**Preparation:** Narrator enters carrying a lighted candle to light the fire.

NARRATOR: This light is the symbol of a Cub Scout's promise to do his best to do his duty to God and his country, to help other people, and to obey the Law of the Pack. We light our fire tonight with the spirit of Scouting. (*Lights the fire with the candle.*)

## Campfire and Candles

**Materials:** Leader and seven boys holding candles

LEADER: (*Lights candle from campfire.*) Welcome to our campfire. Let us draw from it the warmth of Scouting and the spirit of brotherhood. (*Lights candle of Cub Scout 1.*)

CUB SCOUT 1: In its light, we see new chances to be helpful and to do our best. (*Lights candle of Cub Scout 2.*)

CUB SCOUT 2: In its warmth, we think about friends and learning how to get along with others. (*Lights candle of Cub Scout 3.*)

CUB SCOUT 3: In the rocks around the fire that contain the fire, we learn to control our tempers and become good citizens. (*Lights candle of Cub Scout 4.*)

CUB SCOUT 4: From the smoke that rises, we learn to do our duty to God. (*Lights candle of Cub Scout 5.*)

CUB SCOUT 5: The spark that lit this fire reminds us that small things can lead to greater good deeds. (*Lights candle of Cub Scout 6.*)

CUB SCOUT 6: Fire needs to have wood to burn brightly, and we need the care and love of our families as we grow. (*Lights candle of Cub Scout 7.*)

CUB SCOUT 7: In the flames of this campfire, we see the fun of Cub Scouting! (*All Cub Scouts blow out their candles.*)

## Invocation of the Fire

CUB SCOUT 1: May this be a fire of peace and goodwill where we may gather and share our thoughts.

CUB SCOUT 2: As this fire keeps us warm, may it also warm our spirits.

CUB SCOUT 3: In the beauty of the flames, may we see the ever-changing beauty of the world.

CUB SCOUT 4: May this fire be a place where fellowship, adventure, and fun sit side-by-side.

CUB SCOUT 5: May this fire, this night, remain forever in our hearts as the first fire kindled by humans has stayed a part of us through the ages.

## Outdoor Code

**Preparation:** Five boys walk in with the U.S. flag.

CUB SCOUT 1: As an American, I will do my best to be clean in my outdoor manners.

NARRATOR: I will treat the outdoors as a heritage. I will take care of it for myself and others. I will keep my trash and garbage out of lakes, streams, fields, woods, and roadways.

CUB SCOUT 2: As an American, I will be careful with fire.

NARRATOR: I will prevent wildfire. I will build my fires only where they are appropriate. When I have finished using fire, I will make sure it is cold-out. I will leave a clean fire ring or remove all evidence of my fire.

CUB SCOUT 3: As an American, I will be considerate in the outdoors.



NARRATOR: I will treat public and private property with respect. I will use low-impact methods of hiking and camping.

CUB SCOUT 4: As an American, I will be conservation-minded.

NARRATOR: I will learn how to practice good conservation of soil, waters, forests, minerals, grasslands, wildlife, and energy. I will urge others to do the same.

CUB SCOUT 5: Let us think about these responsibilities as we stand and sing “America the Beautiful.”

### **Campfire Advancement**

**Preparation:** Start with a very small campfire and have small pieces of tinder attached to each award. Each boy adds his piece of wood to the fire after receiving his award.

NARRATOR: Our Cub Scouts have worked hard this month on achievements, electives, and activity badges. As they learn and grow, they are adding fuel to the fire that makes our pack go. As each of you receives your award tonight, you will add a piece of tinder to help our campfire grow also. *(Call the boys and parents forward to receive Tiger Track beads; Bobcat, Tiger Cub, Wolf, and Bear badges; Arrow Points; Webelos activity badges; Webelos badges, and Arrow of Light Awards.)* You can see what a difference this tinder has made to the fire of Scouting in our pack!

### **Circle of Light**

CUB SCOUT 1: As darkness creeps into our circle of light,

CUB SCOUT 2: Embers that glow and sigh,

CUB SCOUT 3: Draw our friendship circle closer,

CUB SCOUT 4: Whisper memories that will not die.

CUB SCOUT 5: God’s magic dances in our fire’s flames,

CUB SCOUT 6: And fills the gathering night

CUB SCOUT 7: With mystery and a wondrous peace

CUB SCOUT 8: That brings safe sleep ’til morning’s light.

### **Benediction**

CUB SCOUT 1: May the silence of the hills,

CUB SCOUT 2: The joy of the wind,

CUB SCOUT 3: The music of the birds,

CUB SCOUT 4: The fire of the sun,

CUB SCOUT 5: The strength of the trees,

CUB SCOUT 6: And the faith of youth,

CUB SCOUT 7: In all of which is God,

CUB SCOUT 8: Be in our hearts now and evermore.

### **Irish Blessing**

NARRATOR: May the blessed sunlight shine upon you and warm your heart until it glows like a great fire, so that a stranger may come and warm himself at it, and also be a friend.

### **Light of Day Has Left Us**

CUB SCOUT 1: The light of day has left us.

CUB SCOUT 2: Our campfire burns low.

CUB SCOUT 3: A good day of Scouting done, we can sit back and consider our rewards.

CUB SCOUT 4: The whole of nature surrounds us: towering trees, running water, green grass, hills and valleys, animals, stars, and especially good friends.

CUB SCOUT 5: Our fire still warms us against the chill night air.

CUB SCOUT 6: The fire focuses our attention, embers glowing, giving a soft light to silhouettes.

CUB SCOUT 7: We remember our hours of teamwork, as we became a Scouting family.

CUB SCOUT 8: While the fire becomes ashes and only a memory, our friendship and our Scouting traditions go on forever.



# CHAPTER 12

## Den Chief and Adult Ceremonies



**Why Do We Recognize Den Chiefs and Adults?, 12-2**  
**Ceremonies**

**Den Chief Induction No. 1—Twisted Cord, 12-2**  
**Den Chief Induction No. 2, 12-2**  
**Den Chief Induction No. 3, 12-2**  
**Den Chief Service Award, 12-3**  
**Den Leader Induction, 12-3**  
**Cubmaster Induction, 12-3**

**Pack Leaders and Pack Committee Induction, 12-4**  
**Den Leader Recognition, 12-4**  
**Cubmaster Recognition, 12-4**  
**Appreciation for Service, 12-4**  
**Leader Training—The Pack Helps the  
Cub Scout Grow, 12-4**  
**Leader Training Awards, 12-5**

## Why Do We Recognize Den Chiefs and Adults?

Cub Scout packs would not be in operation if we didn't have adults and den chiefs involved in the program. When we have induction ceremonies, we are outlining the responsibilities of their positions and are letting them know that we appreciate their services. Often, these people will go beyond the regular service asked for and earn awards for their position. Let's not keep it a secret. Share the good news with the entire pack.

Also, saying "thank you" is something we learn. When adults plan ceremonies to recognize other adults and den chiefs, we are really teaching boys how to do this, too. You'll find fun ideas to use for den chief and adult appreciation in Chapter 3. Look for opportunities to let your volunteers know how much you appreciate their service.

### Den Chief Induction No. 1—Twisted Cord (For den chiefs who are members of a Boy Scout troop)

**Materials:** Two 4-foot lengths of rope made from yarn (one blue and one yellow), *Den Chief Handbook*, den chief shoulder cord

NARRATOR: Will Den [number or name], Den Chief [Name], and Den Leader [Name] please come forward. *(Pause.)*

Cub Scouts and friends of Pack [number], we wish to recognize a new leader who will serve as den chief of Den [number or name]. This blue rope (*bold up blue rope*) represents the Cub Scout pack with all its Scouts, leaders, and parents. It also represents the Cub Scout Promise and Law of the Pack. (*Hand the blue rope to a Cub Scout.*) This gold rope (*bold up gold rope*) represents the Scout troop and its leaders, the Scout Oath, and the Scout Law. (*Hand the gold rope to the den chief.*)

You will notice that each of these ropes is made from many strands, representing all the boys in the Cub Scout pack and Boy Scout troop. Let us bind together these two ropes into a bond of friendship. (*The Cub Scout and the den chief each grasp the end of the other's rope and twist in opposite directions.*)

You will now see that these ropes have become the symbol of the den chief's office—the den chief cord. (*The narrator takes the rope in his hands and holds it up.*) Den Leader [Name] will now present his symbol of office.

DEN LEADER: (*Places the cord on the den chief's left shoulder.*) We want to recognize the importance of the service you are giving by presenting you with this *Den Chief Handbook*. (*Presents the book and gives the den chief the Cub Scout handshake.*)

NARRATOR: Welcome to our pack, and thank you! (*The Cubmaster and the Cub Scouts in the den each give the den chief a Cub Scout handshake.*)

### Den Chief Induction No. 2 (For den chiefs who have been Cub Scouts)

**Materials:** Den chief cord

NARRATOR: Cub Scouting is different from Boy Scouting. Like Boy Scouting, there are games, crafts, advancements, and service projects. The biggest difference between the two programs is in the type of activities that we do. The person who knows these activities best is one who has been a Cub Scout.

It's the job of den chiefs to help lead den activities that will help boys achieve the purposes of Cub Scouting. Den chiefs set a good example by being both good leaders and friends. Not only do den chiefs participate in troop, patrol, and crew activities, they attend den chief training and den and pack meetings.

Tonight, we want to recognize those who will serve our pack as den chiefs. (*Call the names.*) Will you please make the Scout sign and repeat the den chief pledge after me:

I promise to help the Scouts in my den  
To the best of my ability;  
To encourage, guide, and protect them in  
den and pack activities,  
And to show them by my example  
What a good leader is.  
I will strive to be prompt and dependable  
And to cooperate with the leaders  
In carrying out the Cub Scout program.

Thank you for all you are doing for our pack! (*Present the den chief cord.*)

### Den Chief Induction No. 3

**Materials:** Den chief cord

NARRATOR: We have some new leaders here today whom we want to welcome into our pack. These leaders will be the activity assistants in the den. They will lead games, teach songs, help with ceremonies and skits, and bring special Scouting skills to the den. These new leaders are our den chiefs. (*Call the den chiefs forward.*)

These Boy Scouts [and/or Varsity Scouts and/or Venturers] will not only serve as assistants in our dens and pack, they are also charged with the larger responsibility of serving as models for Cub Scouts. They are living examples of the Scout Oath and Law. They will be both teachers and friends to our Cub Scouts.

Den chiefs, please repeat after me:

I, [Name], promise to do my best  
To help the Cub Scouts of this pack  
To do their best.

Congratulations! We want to present you with your den chief cord. (*Have the den leader hand a cord to each den chief and give a Cub Scout handshake.*)

## Den Chief Service Award

**Preparation:** Have a Den Chief Service Award cord for the den chief. Arrange to have the Scoutmaster [or Varsity Scout Coach or Venturing Advisor] attend the ceremony. If this award already has been presented at a Boy Scout troop meeting, the den chief can still be recognized at a pack meeting.

**NARRATOR:** Will the following people please come forward. (*Call the den chief, Scoutmaster [Varsity Scout Coach or Venturing Advisor], and den leaders.*)

The Den Chief Service Award recognizes den chiefs, who lead and serve their dens for at least one year. This award emphasizes their key role within Scouting and compliments them for their important service. It is the den chief who brings the fun of Boy Scouting [and/or Varsity Scouts and/or Venturing] to Cub Scouts and who helps bring eager Webelos Scouts into the Boy Scout troop.

Den Chief [Name], have you helped the Cub Scouts in your den to the best of your ability? (*Den chief responds "yes."*) Have you encouraged, guided, and protected them in den and pack activities? (*Den chief responds "yes."*) Have you shown them by example what a Boy Scout [Varsity Scout or Venturer] can be? (*Den chief responds "yes."*)

Pack [number] thanks and congratulates you for your part in the success of our pack. (*At this point, allow the Scoutmaster [Varsity Scout Coach or Venturing Advisor] to make any comments.*)

Den leaders, do you have anything you would like to say? (*Allow them a minute to respond.*) At this time, we would like your den leader to place on your left shoulder your new service award cord. (*The den leader places the cord on the den chief's left shoulder.*)

Let's all show our appreciation for our den chief. (*Lead an appropriate applause.*)

## Den Leader Induction

**Materials:** Holder with six candles or lights

**NARRATOR:** Will the following people please come forward. (*Call the names of the new den leaders and Webelos den leaders.*) Tonight, we have the honor of inducting our new den leaders.

(*Light the first candle or light.*) This light is the light of Scouting. Will one of you please light a second candle? (*Candle is lit.*) This light represents the first step in a boy's Cub Scout life, the Bobcat badge. For you, it's a symbol of your acceptance of your position and your promise to do your best to help these boys learn and grow in both mind and body. If you accept this responsibility, please give the Cub Scout sign and say, "I do." (*Pause for the leaders to respond.*)

Please light the third candle. (*Candle is lit.*) This is the symbol of the Tiger Cub, the second step in a boy's progress. For you, it's the symbol of your promise to do your best for the Cub Scouts in your den and pack. If you

will always try to do your very best, please give the Cub Scout sign and say, "I do."

Please light the fourth candle. (*Candle is lit.*) This is the symbol of the Wolf rank, the third step in a boy's progress. For you, it's the symbol of your promise to attend monthly Cub Scout leader roundtable meetings, where you will find help for projects and fun and games for your den. If you now pledge to attend roundtable each month, please give the Cub Scout sign and say, "I do." (*Pause for the leaders to respond.*)

Please light the next candle. (*The candle is lit.*) This is a symbol of the Bear badge and your promise to seek knowledge for your position at Cub Scout leader training. If you now promise to seek training, give the Cub Scout sign and say, "I do." (*Pause for the leaders to respond.*)

Please light the final candle. (*The candle is lit.*) This is the symbol of the Webelos Scout and your symbol for enthusiasm. Do you now promise to share your enthusiasm for Scouting with the boys in your den? (*Pause for the leaders to respond.*)

Congratulations! May you serve well the Tiger Cubs, Cub Scouts, and Webelos Scouts in your dens.

## Cubmaster Induction

**Preparation:** Assemble a symbol for each quality listed below: a telephone, diploma, paper-cup megaphone, and walking stick. Present each to the Cubmaster during the ceremony. Each one can be symbolized with a cardstock cutout. The committee chair is assisted by committee members, den leaders, and families.

**COMMITTEE CHAIR:** As you accept the responsibilities and challenges of the position of Cubmaster, we have some items that will help you succeed in your efforts.

**PERSON 1:** I want to present you "good communication," because communication will be at the root of your success. (*Present the telephone.*)

**PERSON 2:** I want to present you with "knowledge," beginning with your attendance at Cub Scout leader training. Your understanding of the Cub Scout program will ensure that we remember the purposes of Cub Scouting in everything we do. (*Present the diploma.*)

**PERSON 3:** I present you with "enthusiasm," because this will motivate you and the adults and boys in our pack. (*Present the paper-cup megaphone.*)

**PERSON 4:** I present you with "support," which represents the assistance you will receive from each family in our pack. (*Present the walking stick.*)

**COMMITTEE CHAIR:** As our pack leader, you are the guiding hand behind other pack leaders and serve as program adviser to the pack committee. You are a recruiter, a supervisor, a director, a planner, and a motivator of other leaders. But beyond all this, your most important task is to make sure that what we are doing is in the best



interest of the boys in our pack. Thank you for taking on this rewarding challenge.

## Pack Leaders and Pack Committee Induction

CHARTERED ORGANIZATION REPRESENTATIVE: It takes many people with lots of different talents working together to make our pack go. Will the following people please come forward. (*Call the title and names of the pack committee chair, the pack committee members, the Cubmaster, the assistant Cubmasters, the den leaders, the assistant den leaders, the pack trainer, the ScoutParents unit coordinator, and the den chiefs.*)

These people have accepted the challenge and responsibility of working with the boys and families in our pack this year to achieve the aims of Scouting. These aims are building character, citizenship, and personal fitness in our boys.

Do you accept the challenges and responsibilities in assuming your position? (*Pause for the response.*) Will you attend Cub Scout Leader Basic Training, pow wow, and Cub Scout roundtables so that the knowledge you find there can help make our pack meet the aims and purposes of Cub Scouting? (*Pause for the response.*)

Let's all pledge to work with them in achieving this goal. Please stand, make the Cub Scout sign, and say the Cub Scout Promise together.

## Den Leaders Recognition

**Preparation:** Make a special award or certificate for each leader. (See Chapter 3 for ideas.)

NARRATOR: Den leaders are regular people, just like you and me. They give a special gift to our children: their time. They attend training, attend Cub Scout leader roundtables, plan den meetings, meet with other pack leaders, watch for new ideas, call families, and play with our boys. The time that they spend helps mold our Cub Scouts into the type of men we wish them to become—responsible people who are strong in mind and character.

We want the best for our children. Tonight, we wish to thank those who have given their best. Will the following special people please come forward. (*Call the names of the den leaders and present each one with a special certificate or award.*)

## Cubmaster Recognition

**Preparation:** Make a special award or certificate. (See Chapter 3 for ideas.)

NARRATOR: Cub Scouts learn that Akela means leader. They honor Akela by listening to that person and following that person. One person who represents Akela to us is our Cubmaster. We listen to our leader's words and follow

the Cubmaster's example of service. Our Cubmaster is enthusiastic and idealistic and tries to set the example by living these ideals. The question the Cubmaster uses as a guideline is, "What is best for the boys?"

We want to honor Akela tonight and thank our Cubmaster for guidance and inspiration. (*Present a special certificate or award.*)

## Appreciation for Service

**Materials:** A certificate and a "Nice Job" pin

NARRATOR: Today, we would like to honor someone in our pack who has shown unselfish service by (*list the unselfish service*). Will [Name] please come forward. (*Pause.*)

On behalf of our pack committee and chartered organization, I would like to present to you this certificate of appreciation for your service as (*list the role this person assumed*). (*Present the certificate.*) We also want to present you with a pin that can be worn only by those who have served Scouting in an extra special way. We feel you should have this pin in recognition of your service to our pack. (*Present the pin.*)

Please join me in showing an expression of our appreciation. (*Lead an appropriate applause.*)

## Leader Training—The Pack Helps the Cub Scout Grow

**Materials:** A yardstick with a drawing of a Cub Scout mounted on the top and yellow and blue marking pens

NARRATOR: Today, we will be recognizing some of our leaders for helping our pack grow. Would the following leaders please come forward? (*Call the names.*)

The Law of the Pack guides us all. One of the lines in the Law of the Pack says, "The pack helps the Cub Scout grow." These pack leaders are helping our Cub Scouts grow by taking extra time to learn about the Cub Scout program and things we can do in our dens and pack. (*Make comments about the training event that they have attended, such as Cub Scout Leader Basic Training, pow wow, den chief training conference, or Wood Badge.*)

Tonight, we are marking this growth with an inch for each training. (*Have leaders mark yardstick with alternating stripes of blue and gold.*) Please stand and join these leaders in saying the Law of the Pack. (*All give Cub Scout sign and say the Law of the Pack together.*)

Let's show our appreciation of these leaders. (*Lead an appropriate applause.*)

## Leader Training Awards

**Materials:** A small toy car or drawing of one for each leader (or present a flower)

COMMITTEE CHAIR OR CUBMASTER: Every month at our pack meeting, we recognize the Cub Scouts who receive awards. Today, we would like to recognize a leader who has received a special award. Will [Name] please come forward.

To receive this award, a leader must be trained, participate in special extra training, work as a leader in that position for a given period of time, and do several other requirements. It sounds like a lot of work, and it is, but this leader has had as much fun earning this recognition as you Cub Scouts and Webelos Scouts do while earning yours.

[Name] has earned the *(read the name of the recognition award earned)*. He/she has received a certificate and a special square knot to wear on the uniform. As Akela, you have really helped our pack go and our Cub Scouts grow *(add "and our district glow," if appropriate)*.

We would like to present this special symbol of our thanks. *(Present the recognition item from the pack.)* Congratulations, and thank you again for all your hard work.



## Cub Scout Ceremonies for Dens and Packs

Important Dates in Cub Scouting History, A-1  
Resources, A-1

New Ceremonies Recommendation Form, A-3

### Important Dates in Cub Scouting History

- 1910 Boy Scouts of America incorporated on February 8
- 1916 BSA chartered by Congress in June
- 1930 The Cubbing program started
- 1940 Program themes introduced
- 1941 Webelos rank created in Cubbing
- 1943 Blue and gold banquet materials developed
- 1945 “Cubbing” changed to the Cub Scout program
- 1947 Long trousers introduced
- 1949 Age limits lowered to 8 for Cub Scouting, 11 for Boy Scouts, and 14 for Explorers
- 1954 Webelos dens introduced as a bridge to Boy Scouts
- 1955 Pinewood derbies introduced
- 1964 National Summertime Pack Award created
- 1967 Lion rank discontinued and Webelos program for 10-year-olds introduced with 15 activity badges
- 1968 Cub Scout day camp program approved
- 1971 Cub Scout Promise changed from “be square” to “help other people.”
- 1980 New uniforms designed for boys and leaders
- 1980 50th anniversary of Cub Scouting in the United States
- 1982 Tiger Cubs BSA introduced
- 1986 Cub Scouting program expanded to serve all elementary school grades
- 1991 Ethics in Action and BSA Family programs introduced

### Resources

Where do Cub Scout leaders find materials and resources for ceremonies? Everywhere! Use your imagination, and you will find and create what you need! (Also, for more information, refer to the current BSA catalog.)

#### BSA Printed Reference Materials

*Cub Scout Ceremonies for Dens and Packs*, No. 33212

*Cub Scout Leader Book*, No. 33221

*Cub Scout Leader How-To Book*, No. 33832

*Cub Scout Roundtable Guide*, No. 34410

*Cub Scout Songbook*, No. 33222

*Den & Pack Meeting Resource Guide*, No. 34409

*Webelos Leader Guide*, No. 33853

*Your Flag*, No. 33188

#### Stickers/Posters

Cub Scout Stickers, 2½ by 5½ inches (8), No. 34015

Cub Scout Achievement Stickers (set of badges), 2¼ by 2¼ inches, No. 4455D

Cub Scout Extra Large Insignia Stickers (set of badges), 4¼ by 4¼ inches, No. 34650

Cub Scout Bobcat Stickers, 2½ by 5½ inches (8), No. 34014

Cub Scout Wolf Stickers, 2½ by 5½ inches (8), No. 34010

Cub Scout Bear Stickers, 2½ by 5½ inches (8), No. 34011

Webelos Scout Stickers, 2½ by 5½ inches (8), No. 34012

## **"Fun for the Family" Award**

Fun for the Family Book, No. 33012

Fun for the Family Award certificate, No. 33710

Shaping Your Family Identity pin, No. 14354; patch, No. 18094

Developing Personal Skills pin, No. 14355; patch, No. 18095

Building a Family Team pin, No. 14356; patch, No. 18096

Connecting With Your Community pin, No. 14353; patch, No. 18097

Facing Family Challenges pin, No. 14352; patch, No. 18098

## **Pins/Certificates/Ribbons**

Arrow of Light Wall Certificate, No. 34215

Cub Scout Appreciation Certificate, 10-by-8 inch blue foil, No. 34069

Cub Scout Pack Graduation Wall Certificate, 10-by-8 inches, No. 33751

Den Chief Award Service Certificate, No. 33726

Pack Leader Appreciation Certificate, No. 33755

Ribbons—Cub Scout "I'm a Winner," No. 17804

Ribbons—"I Did My Best," No. 17803

## **Special Awards**

Cub Scout Thank You Paperweight, No. 17696

Marbleized Den Leader Appreciation Plaque, No. 17733

## **Other Resources**

Cub Scout leaders' roundtable

Cub Scout leaders' pow wow

Council Service Center

Local Scout Shop

[www.Scouting.org](http://www.Scouting.org)

[www.JoinCubScouting.org](http://www.JoinCubScouting.org)

[www.scoutstuff.org](http://www.scoutstuff.org)



# New Ceremonies Recommendation Form

Date:

To: Innovation Team (S320)  
Boy Scouts of America  
1325 West Walnut Hill Lane  
P.O. Box 152079  
Irving, TX 75015-2079

Our pack has developed a ceremony that we recommend for the next version of *Cub Scout Ceremonies for Dens and Packs*.

## Category—circle one:

- |                           |  |
|---------------------------|--|
| Den Ceremony              | Advancement                              |
| Pack Opening Ceremony     | Transition                               |
| Induction to Cub Scouting | Adult Recognition and Den Chief Ceremony |
| Pack Closing Ceremony     | Other type of ceremony: _____            |

## Materials needed:

## Ceremony description:

Name: \_\_\_\_\_

Address: \_\_\_\_\_

City: \_\_\_\_\_ State: \_\_\_\_\_ Zip: \_\_\_\_\_

Telephone: \_\_\_\_\_ Fax: \_\_\_\_\_ E-mail: \_\_\_\_\_

Council: \_\_\_\_\_ Pack No: \_\_\_\_\_



# Cub Scout Ceremonies for Dens and Packs

## A

Academics and Sports Awards, 10-3  
 Achieve opening pack ceremony, 5-6  
 Activity badge presentation, Webelos, 10-2  
 Adapting advancement ceremonies, 8-2  
 Adult ceremonies, listed, 12-1  
 Adult recognition, Appreciation for Service, 12-4  
 Advancement  
   ceremonies, adapting, 8-2  
   ceremonies encourage advancement, 1-3  
   ceremonies, listed, 8-1-2  
   Cub Scout, goals of, 1-3  
   props, 8-2  
   What is?, 1-3  
   Why advancement ceremonies?, 8-2  
 Airplane advancement ceremony, 8-3  
 Akela Transition Ceremony for Tiger Cubs, 9-3  
 All-Purpose, All-Occasion Ceremony Creator form, 10-5  
 America—The Song, opening pack ceremony, 5-2  
 A-M-E-R-I-C-A opening pack ceremony, 5-2  
 America's Answer closing pack ceremony, 6-2  
 Anniversary Ceremony, Silver or Gold Pack, 10-5  
 Apple Seeds closing pack ceremony, 6-3  
 Appreciation  
   awards, 3-2  
   ideas, 3-2  
   for Service, 12-4  
 Arrow of Light ceremonies  
   Climbing the Ladder, 8-11  
   History of Cub Scouting, 8-9  
   Inventions and Computers, 8-10  
   Meaning of the Blue and Gold, 8-11  
   Painted Paws, 8-8  
   Six Steps to Boy Scouting, 8-11  
   Spirit of Scouting, 8-14  
   Top of the Mountain, 8-13  
   Value of a Badge, 8-12  
   Woodworking, 8-13  
   Yule Log, 8-13  
 Arrow Points ceremony, Gold and Silver, 10-2  
 Assistant Denner Installation, 2-4  
 Award and appreciation ideas, 3-2  
 Awards  
   den chief service, 12-3  
   leader training, 12-5

## B

Baden-Powell opening pack ceremony, 5-6  
 Badges of Cloth opening pack ceremony, 5-6  
 Balloons, Immediate Recognition in den, 2-4  
 Baseball advancement ceremony, 8-4  
 Bear Cub Scout ceremonies  
   Airplane, 8-3  
   Baseball, 8-4  
   Climbing the Ladder, 8-11  
   Fishing for Advancement, 8-4  
   Fitness, 8-5  
   History of Cub Scouting, 8-9  
   Inventions and Computers, 8-11  
   Jungle Book, 8-3  
   Knights of the Round Table, 8-5  
   Meaning of the Blue and Gold, 8-11  
   Mountain Climbing, 8-5  
   Our Flag, 8-6  
   Painted Paws, 8-8  
   Pinewood Derby, 8-6  
   Radio Station C-U-B-S, 8-7  
   Six Steps to Boy Scouting, 8-11  
   Swimming, 8-7  
   Value of a Badge, 8-12  
   Wagon Train, 8-8  
   Woodworking, 8-13  
   Yule Log, 8-13  
 Bear-to-Webelos transition ceremonies  
   Four Winds, 9-4  
   Neckerchief Ceremony, 9-3  
 Bear Trail Adventure transition ceremony, 9-3  
 Benediction outdoor ceremony, 11-3  
 Bird Nest closing pack ceremony, 6-3  
 Bird Watchers closing pack ceremony, 6-3  
 Blue and Gold Banquet, Silver or  
   Gold Pack Anniversary Ceremony at, 10-5  
 Blue and Gold closing pack ceremony, 6-3  
 Bobcat ceremonies  
   Airplane, 8-3  
   Baseball, 8-4  
   Climbing the Ladder, 8-11  
   Cub Scout Shirt Bobcat Recognition in Den, 2-3  
   Fishing for Advancement, 8-4  
   Fitness, 8-5  
   History of Cub Scouting, 8-9  
   Inventions and Computers, 8-10  
   Jungle Book, 8-3

- Key to Cub Scouting, 8-2
- Knights of the Round Table, 8-5
- Meaning of the Blue and Gold, 8-11
- Mountain Climbing, 8-5
- On the Cub Scout Trail, 7-2
- Our Flag, 8-6
- Pinewood Derby, 8-6
- Radio Station C-U-B-S, 8-7
- Six Steps to Boy Scouting, 8-11
- Swimming, 8-7
- Value of a Badge, 8-12
- Wagon Train, 8-8
- Woodworking, 8-13
- Yule Log, 8-13
- Bobcat Recognition in Den, Cub Scout Shirt, 2-3
- Boy Scout Handshake closing den ceremony, 2-4
- Boy Scout Motto opening den ceremony, 2-3
- Boy Scout Oath
  - Meaning of, den closing ceremony, 2-5
  - opening den ceremony, 2-3
- Bridge (transition ceremonies)
  - Colors of the Wind, 9-4
  - Cub Scout Trail, 9-5
  - Seven Virtues of Life, 9-4
- Brotherhood Circle Closing den ceremony, 2-4
- Building a Flag opening pack ceremony, 5-2

**C**

- Campfire Advancement outdoor ceremony, 11-3
- Campfire ceremonies, listed, 11-1
- Campfire Lighting outdoor ceremony, 11-2
- Campfire and Candles outdoor ceremony, 11-2
- Centennial Quality Unit Award, 10-4
- Ceremony Creator form, All-Purpose, All-Occasion, 10-5
- Ceremony equipment, 3-3
- Ceremonies
  - adapting, 1-3
  - kinds of, 1-2
  - limitations, 1-3
  - music in, 3-7
  - planning your pack, 3-2
  - tips for effective, 1-2
  - Why do we use?, 1-2
- Charter Presentation, Pack, 10-4
- Circle of Light outdoor ceremony, 11-3
- Climbing the Ladder advancement ceremony, 8-11
- Clip art to use in ceremonies, 3-5
- Closing Thoughts, Short pack, closing ceremony, 6-2
- Closing ceremonies, den. *See also* Tiger Cub ceremonies.
  - A Valuable Opportunity, 6-2
  - Brotherhood Circle Closing, 2-4
  - Den Yell Recognition ceremony, 2-5
  - Flag Folding, 2-5
  - Friendship Circle, 2-5
  - Grand Howl, 2-5
  - Handshake Closing, 2-4
  - Leader's Minute, 2-5
  - Living Circle, 2-5

- Meaning of the Cub Scout Promise or Boy Scout Oath, 2-5
- Mountain Climbing Closing Thought, 2-5
- My Flag, 2-5
- Patriotic Song Closing, 2-5
- Square Knot, 2-5
- We Meet as Cub Scouts/Webelos Scouts, 2-5
- Closing ceremonies, pack meeting, listed, 6-1-2
- Closing Thought, Mountain Climbing, 2-5
- Colors of the Wind transition ceremony, 9-4
- Compass closing pack ceremony, 6-3
- Compass Prayer closing pack ceremony, 6-3
- Create or Destroy closing pack ceremony, 6-4
- Creating your own ceremonies, 10-5
- C-U-B-S, Radio Station advancement ceremony, 8-7
- Cub Scout
  - advancement goals, 1-3
  - /Boy Scout Motto Opening den ceremony, 2-3
  - Cycle, 9-2
  - Pocket opening pack ceremony, 5-7
  - Promise, Meaning of, closing den ceremony, 2-5
  - Promise/Scout Oath Opening den ceremony, 2-3
  - Promise in sign language, 5-10
  - Promise Opening, 2-3
  - Shirt Bobcat Recognition in Den, 2-4
  - Spirit opening pack ceremony, 5-7
  - Trail transition ceremony, 9-5
  - Vespers closing pack ceremony, 6-4
  - /Webelos Scout Light den ceremony, 2-3
- Cub Scouting
  - advancement, 1-3
  - history, important dates in, A-1
  - Is Many Things opening pack ceremony, 5-7
- Cubmaster
  - induction, 12-3
  - recognition, 12-4
- Cycle, Cub Scout, 9-2

**D**

- Den award and appreciation ideas, 3-2
- Den Award, National presentation, 10-3
- Den ceremonies. *See also* closing ceremonies, den; opening ceremonies, den.
  - listed, 2-1-2
  - Why do we have them?, 2-2
- Den chief ceremonies, listed, 12-1
- Den Chief Induction
  - No. 1—Twisted Cord, 12-2
  - No. 2, 12-2
  - No. 3, 12-2
- Den Chief Service Award, 12-3
- Den Doodle for Advancement in den, 2-4
- Den doodles, 2-6
- Den Flag Opening ceremony, 2-3
- Den leader
  - induction, 12-3
  - recognition, 12-4
- Den service projects, 10-3

Den Yell Recognition ceremony, 2-5  
Den Yell Opening ceremony, 2-3  
Denner and Assistant Denner Installation, 2-4  
Denner and Cub Scout Stamp Installation, 2-4  
Diagrams of flag positions, 4-7  
Discover America opening pack ceremony, 5-3  
Do Your Best closing pack ceremony, 6-4  
Dominoes closing pack ceremony, 6-4  
Duties as a Citizen opening pack ceremony, 5-3

## E

Effective ceremonies, tips for, 1-2  
Equipment  
    music and, 3-7  
    pack ceremony, 3-3  
Explanation of Pledge of Allegiance opening pack ceremony, 5-3

## F

Family Induction Into the Pack, 7-2  
Fire, Invocation of, 11-2  
Fire Prevention opening pack ceremony, 5-7  
Fishing for Advancement ceremony, 8-4  
Fishing, Immediate Recognition in den, 2-4  
Fitness advancement ceremony, 8-5  
Fitness, Shape Up for, opening pack ceremony, 5-9  
Flag ceremonies  
    comments, 4-2  
    create your own with U.S. flag, 4-2  
    indoor, using flag stands, 4-3  
    outdoor, using flagpole, 4-3  
    planning, 4-2  
    and Pledge of Allegiance, 4-2  
Flag Folding closing den ceremony, 2-5  
Flag of America opening pack ceremony, 5-4  
Flag positions, diagrams of, 4-7  
Flag retiring, 4-5  
Flag stands, standard indoor flag ceremony using, 4-3  
Flag Story opening pack ceremony, 5-4  
Flag, Talking opening pack ceremony, 5-6  
Flagpole, standard outdoor flag ceremony using, 4-3  
Form, New Ceremonies Recommendation, A-3  
Four Winds transition ceremony, 9-4  
Friendship Circle closing den ceremony, 2-5  
Fun for the Family Award, BSA, 10-2

## G

Garden opening pack ceremony, 5-8  
Goals, Cub Scout advancement, 1-3  
Gold Pack Anniversary Ceremony, 10-5  
Gold and Silver Arrow Points ceremony, 10-2  
Gold Arrow Points, Meaning of the Blue and Gold, 8-11  
Good News closing pack ceremony, 6-4  
Grand Howl Recognition den ceremony, 2-5

## H

Halloween closing pack ceremony, 6-4  
Handshake Closing den ceremony, 2-4  
Handshake Opening den ceremony, 2-2  
History of Cub Scouting advancement ceremony, 8-9  
History, Important Dates in Cub Scouting, A-1

## I

I Am an American opening pack ceremony, 5-4  
I Am Your Flag closing pack ceremony, 6-4  
I Asked Myself a Question opening pack ceremony, 5-4  
I Believe opening pack ceremony, 5-4  
I Made a Promise closing pack ceremony, 6-4  
I Will Use My Senses closing pack ceremony, 6-5  
Immediate recognition in den  
    Balloons, 2-4  
    Fishing, 2-4  
    Snowflake, 2-4  
Important Dates in Cub Scouting History, A-1  
Indoor flag ceremony, using flag stands, 4-3  
Induction ceremonies  
    Cubmaster, 12-3  
    den chief, 12-2  
    den leaders, 12-3  
    listed, 7-1  
    pack committee, 12-4  
    pack leaders, 12-4  
    Webelos den leaders, 12-3  
    Why do we have?, 7-2  
Installation  
    Assistant Denner, 2-4  
    Denner, 2-4  
    Denner and Cub Scout Stamp, 2-4  
Inventions and Computers advancement ceremony, 8-10  
Invocation of the Fire outdoor ceremony, 11-2  
Irish Blessing outdoor ceremony, 11-3

## J

Jungle Book advancement ceremony, 8-3

## K

Key to Cub Scouting advancement ceremony, 8-2  
Knights of the Round Table advancement ceremony, 8-5  
Knights opening pack ceremony, 5-8

## L

Law of the Pack/Scout Law Opening den ceremony, 2-3  
Layout, pack meeting, 3-2  
Leader recognition  
    Cubmaster, 12-4  
    den leader, 12-4  
Leader training  
    awards, 12-5  
    The Pack Helps the Cub Scout Grow, 12-4  
Leader's Minute den closing, 2-5



Light of Day Has Left Us outdoor ceremony, 11-3  
Light Switch closing pack ceremony, 6-5  
Living Circle den closing ceremony, 2-5

## M

Magic opening pack ceremony, 5-8  
Making a Difference closing pack ceremony, 6-5  
Mark of the Tiger transition ceremony, 9-3  
Meaning of Blue and Gold advancement ceremony, 8-11  
Meaning of Cub Scout Promise or Scout Oath den closing ceremony, 2-5  
Mountain Climbing advancement ceremony, 8-5  
Closing Thought den ceremony, 2-5  
Music in ceremonies, 3-7  
Musicians, guest, 3-7  
My Backyard opening pack ceremony, 5-8  
My Flag closing den ceremony, 2-5

## N

National Den Award presentation, 10-3  
National Summertime Pack Award, Twelve Months of Scouting, 10-4  
Nature Visitors closing pack ceremony, 6-5  
Neckerchief Ceremony transition, 9-3  
Neighborhood opening pack ceremony, 5-9  
New Ceremonies Recommendation form, A-3

## O

Old Glory opening pack ceremony, 5-5  
On the Cub Scout Trail induction, 7-2  
One Candle closing pack ceremony, 6-5  
Opening ceremonies, importance of pack, 5-2  
Opening ceremonies, den. *See also* Tiger Cub Ceremonies.  
Create your own with the U.S. flag, 4-2  
Cub Scout Promise/Scout Oath Opening, 2-3  
Cub Scout/Scout Motto Opening, 2-3  
Cub Scout/Webelos Scout Light, 2-3  
Den Flag Opening, 2-3  
Den Yell Opening, 2-3  
Handshake Opening, 2-2  
Law of the Pack/Scout Law Opening, 2-3  
Pledge of Allegiance Opening, 2-3  
Roll Call Opening, 2-3  
Tiger Cub Opening, 2-2  
Tiger Cub Roll Call Opening, 2-2  
Opening/Closing Song Ceremony (den), 2-3  
Opening pack ceremonies, listed, 5-1-2  
Orange Bead Recognition den ceremony, 2-2  
Our American Heritage opening pack ceremony, 5-5  
Our Country Is Different opening pack ceremony, 5-5

Our Flag advancement ceremony, 8-6  
closing pack ceremony, 6-5  
opening pack ceremony, 5-5  
Outdoor Benediction, 11-3  
Outdoor and campfire ceremonies listed, 11-1  
planning, 11-2  
Scouting goes outdoors, 11-2  
Outdoor Code outdoor ceremony, 11-2

## P

Pack anniversary, gold or silver, 10-5  
Pack ceremonies closing, listed, 6-1-2  
opening, listed, 5-1-2  
planning your, 3-2  
Pack ceremony equipment, 3-3  
Pack Charter Presentation, 10-4  
Pack Leaders and Pack Committee Induction, 12-4  
Pack meeting closing ceremonies, listed, 6-1-2  
layout, 3-2  
opening ceremonies, listed, 5-1-2  
Painted Paws advancement ceremony, 8-8  
Parents closing pack ceremony, 6-6  
Patriotic Song Closing den ceremony, 2-5  
Pinewood Derby advancement ceremony, 8-6  
Planning ceremony, 9-2  
flag ceremonies, 4-2  
outdoor ceremonies, 11-2  
your pack ceremonies, 3-2  
Pledge of Allegiance den opening ceremony, 2-3  
Explanation of, opening pack ceremony, 5-3  
and flag ceremonies, 4-2  
introductory statements for, 4-2  
When?, 4-2  
Pocketknife closing pack ceremony, 6-6  
Presentation of colors flagpole, 4-6  
indoors, 4-4  
Props, advancement, 8-2

## R

Radio Station C-U-B-S advancement ceremony, 8-7  
Recipe for Cub Scouting induction, 7-3  
Recognition Cubmaster, 12-4  
den leader, 12-4

- for adults, Appreciation for Service, 12-4
- in den, Balloons Immediate, 2-4
- in Den, Cub Scout Shirt Bobcat, 2-3
- in den, Den Doodle, 2-4
- in den, Fishing Immediate, 2-4
- in den, Snowflake Immediate, 2-4
- leader training, 12-5
- Orange Bead Recognition den ceremony, 2-2
- other times for, 10-2
- White Bead Recognition den ceremony, 2-3

Resource list, A-1-2

Retiring of colors

- flagpole, 4-6
- indoors, 4-5

Ripple Effect closing pack ceremony, 6-6

Roll Call Opening den ceremony, 2-3

## S

- Scout Benediction closing pack ceremony, 6-6
- Scout Law Opening den ceremony, 2-3
- Scouting History closing pack ceremony, 6-6
- Service Award, Den Chief, 12-3
- Service projects, den, 10-3
- Service Stars, tenure awards, 10-3
- Seven Seas opening pack ceremony, 5-9
- Seven Virtues of Life transition ceremony, 9-4
- Shape Up for Fitness opening pack ceremony, 5-9
- Ships of Scouting opening pack ceremony, 5-9
- Short Closing Thoughts pack closing ceremony, 6-2
- Sign language, Cub Scout Promise in, 5-10
- Silver or Gold Pack Anniversary Ceremony, 10-5
- Silver Arrow Point ceremony, 10-2
- Silver Arrow Points, Meaning of the Blue and Gold, 8-11
- Six Steps to Boy Scouting advancement ceremony, 8-11
- Sky is the Limit closing pack ceremony, 6-6
- Smile closing pack ceremony, 6-6
- Snowflake Immediate Recognition in den, 2-4

Songs

- America—The Song opening pack ceremony, 5-2
- appropriate for opening ceremonies
  - with U.S. flag, 4-2
- Opening/Closing Song den ceremony, 2-3
- Patriotic Song Ending den ceremony, 2-5
- “Taps” With Cub Scout Promise closing pack ceremony, 6-7
- “Taps” With Hand Motions closing pack ceremony, 6-7
- Tiger Cub Closing Song den ceremony, 2-3

Space opening pack ceremony, 5-9

Spirit of Baden-Powell opening pack ceremony, 5-10

Spirit of Scouting advancement ceremony, 8-13

Sports Awards. *See* Academics and Sports Awards.

Sportsmanship closing pack ceremony, 6-6

Square Knot closing den ceremony, 2-5

Stars closing pack ceremony, 6-6

Stick to It Stamp closing pack ceremony, 6-7

Sticks closing pack ceremony, 6-7

- Story of the Blue and Gold opening pack ceremony, 5-10
- Summertime Pack Award, National, 10-4
- Swimming advancement ceremony, 8-7

## T

- Talking Flag opening pack ceremony, 5-6
- “Taps”
  - With Cub Scout Promise closing pack ceremony, 6-7
  - With Hand Motions closing pack ceremony, 6-7
- Ten Needs of a Boy closing pack ceremony, 6-7
- Tenure award. *See* Service Stars.
- Thank You closing pack ceremony, 6-7
- This Is Cub Scouting induction, 7-3

Tiger Cub ceremonies

- Akela Transition Ceremony for Tiger Cubs, 9-3
- Black Bead Recognition den ceremony, 2-3
- Cub Scout Promise, 2-2
- Mark of the Tiger transition ceremony, 9-3
- Neckerchief Ceremony transition, 9-3
- Orange Bead Recognition den ceremony, 2-2
- Tiger Cub Closing den ceremony, 2-3
- Tiger Cub Closing Song den ceremony, 2-3
- Tiger Cub Opening den ceremony, 2-2
- Tiger Cub Immediate Recognition Emblem, 10-2
- Tiger Cub Roll Call Opening den ceremony, 2-2
- Tiger Cubs on the Trail induction ceremony, 7-2
- Tiger Tracks advancement ceremony, 8-3
- What Is Tiger Cub Fun? opening pack ceremony, 5-6
- White Bead Recognition den ceremony, 2-3

Tiger Cub

- Closing den ceremony, 2-3
- Closing Song den ceremony, 2-3
- Immediate Recognition Emblem, 10-2
- Opening den ceremony, 2-2
- Roll Call Opening den ceremony, 2-2

Tiger Cubs on the Trail induction ceremony, 7-2

Timing, Cub Scout Cycle, 9-2

Tips

- for effective ceremonies, 1-2
- for using this book, 1-3

Tires Can Take It closing pack ceremony, 6-8

Top of the Mountain advancement ceremony, 8-12

Training, recognition for leader, 12-4

Transition Ceremonies

- let's have a celebration! 9-2
- planning, 9-2
- timing is everything, 9-2

Trees closing pack ceremony, 6-8

Twelve Months of Scouting (National Summertime Pack Award), 10-4

Twisted Cord, Den Chief Induction No. 1, 12-2

## U

- U.S. flag. *See* flag.

## V

### Value

- of a Badge advancement ceremony, 8-12
- of a Badge closing pack ceremony, 6-8

### Voting opening pack ceremony, 5-6

## W

### Wagon Train advancement ceremony, 8-8

### We Meet as Cub Scouts closing den ceremony, 2-5

### Webelos activity badge ceremonies

- With Colors or Cap, 10-2
- With Samples, 10-3

### Webelos activity badge presentation, 10-2

### Webelos Scouts ceremonies

- Airplane, 8-3
- Baseball, 8-5
- Climbing the Ladder, 8-11
- Fishing for Advancement, 8-4
- Fitness, 8-5
- History of Cub Scouting, 8-9
- Inventions and Computers, 8-11
- Knights of the Round Table, 8-5
- Meaning of the Blue and Gold, 8-11
- Mountain Climbing, 8-5
- Our Flag, 8-6
- Painted Paws, 8-8
- Pinewood Derby, 8-6
- Radio Station C-U-B-S, 8-7
- Six Steps to Boy Scouting, 8-11
- Swimming, 8-7
- Value of a Badge, 8-12
- Wagon Train, 8-8
- Woodworking, 8-13
- Yule Log, 8-13

### Webelos Scout Light den opening ceremony, 2-3

### Webelos-to-Scout transition

- Colors of the Wind, 9-4
- Cub Scout Trail, 9-5
- Seven Virtues of Life, 9-4

### What Is Advancement?, 1-3

### What Is Tiger Cub Fun? opening pack ceremony, 5-6

### White Bead Recognition den ceremony, 2-3

### Wolf Cub Scout ceremonies

- Airplane, 8-3
- Baseball, 8-4
- Climbing the Ladder, 8-11
- Fishing for Advancement, 8-4
- Fitness, 8-5
- History of Cub Scouting, 8-9
- Inventions and Computers, 8-10
- Jungle Book, 8-3
- Knights of the Round Table, 8-5
- Meaning of the Blue and Gold, 8-11
- Mountain Climbing, 8-5
- Our Flag, 8-6
- Painted Paws, 8-8
- Pinewood Derby, 8-6

### Radio Station C-U-B-S, 8-7

### Six Steps to Boy Scouting, 8-11

### Swimming, 8-7

### Value of a Badge, 8-12

### Wagon Train, 8-8

### Woodworking, 8-13

### Yule Log, 8-13

### Wolf-to-Bear transition

#### Bear Trail Adventure, 9-3

#### Neckerchief Ceremony, 9-3

### Woodworking

#### advancement ceremony, 8-13

#### opening pack ceremony, 5-10

### World Conservation Award, 10-3

### World Globe closing pack ceremony, 6-8

## Y

### Yardstick closing pack ceremony, 6-8

### Yule Log advancement ceremony, 8-13

# Do Your Best: What does it mean for a **CUB SCOUT**

# LEADER?

**Be Prepared**  
(with the right leader resources at the right time)

**Be Trained**

**Immediately**  
(before your first meeting with boys)

Den & Pack Meeting Resource Guide



Youth Protection\*  
Cub Scout Fast Start\*

**As You Advance**  
(within 2-3 months)

Leader Book

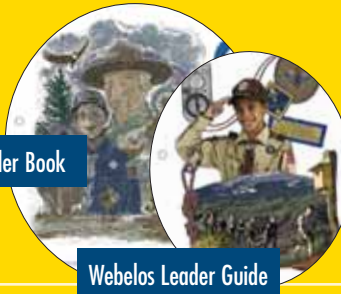

Webelos Leader Guide

This Is Scouting\*

Leader Position-Specific Training



**As Needed**  
By Den and Pack Plans

Leader How-To Book



Academics and Sports

Basic Adult Leader Outdoor Orientation



\*Offered through the Online Learning Center at [www.scouting.org](http://www.scouting.org)



## CUBCAST



**Need a great idea**  
for your den or pack that really works?

**Want to share a great idea**  
that worked in your den or pack?

Then, check out CubCast at  
[www.scouting.org/ScoutCast](http://www.scouting.org/ScoutCast)



BOY SCOUTS OF AMERICA  
1325 West Walnut Hill Lane  
P.O. Box 152079  
Irving, Texas 75015-2079  
<http://www.scouting.org>

SKU 33212



7 30176 32338 1  
33212 2010 Printing